

Cleveland™

STANDARD EQUIPMENT AND ACCESSORIES SUGGESTED LIST PRICE

2025 PRICE LIST



TIMELESS QUALITY
TRUSTED FOR LIFE



EFFECTIVE | JANUARY 1, 2025

1 CLEVELAND IS STEAM

Our sole focus is on Steam Cooking Equipment since 1922. We are North America’s largest steam equipment provider.

2 STATE OF THE ART CONCORD FACILITY

Our state of the art Concord facility is both ASME and ISO 9001 approved.

- ISO9001 Quality System, Since 1997
- ASME - 100 PSI High Pressure Vessel Certified since 1977
- CE Mark Pressure Vessel Approval for Europe since 2002
- SELO of AQSIIQ Pressure Vessel Approval for China.



3 WE OFFER AN EXTENSIVE PRODUCT LINE

More models to suite any application

4 QUICKSHIP WAREHOUSE PROGRAM



QS — QuickShip Items (48 hours)

EX — Express Items (10 work day lead time)

5 BEST IN CLASS

“Best in Class” winner by FE&S Magazine for 16 years; in 2017 winning 10 of 12 Categories.



STEAMERS
(16 times)
Overall Winner
Operators Winner
Consultant Winner
Dealer Winner



KETTLES
(8 times)
Overall Winner
Operators Winner
Dealer Winner



TILT SKILLETS
(9 times)
Overall Winner
Consultant Winner
Dealer Winner

Blue Flame Award 2023 Winner:
Floor Gas Kettles



6 CUSTOMER & TECHNICAL SUPPORT

Steam focused **Customer & Technical Support** via an experienced team ready to help, **both pre-sale and aftermarket!**

7 WARRANTY

A **Unique Warranty** with low industry rates offering the best overall warranty coverage. Our product reliability creates low rates.

STEAMERS

SteamChef Electric, 3 & 6 Pans (22CCT6, 22CET3.1 22CET6.1)..... 5

SteamChef Gas, 3 & 6 Pans (22CGT3.1, 22CGT6.1)..... 6

SteamCraft 3 & 5 Pan (21CET8, 21CET16, 21CGA5)..... 7

SteamCraft, Gemini 10-Pan Steamers (24CGA, 24CEA, 24CGP, 24CDP10)..... 8

Classic Line Steamers, 15 PSI Boilers, Convection, Pressure Steamers..... 9

Modular Bases with Kettles — Classic Line 10

Installation Program, Water Filters..... 11

Steamer Accessories 12

KETTLES

Countertop Electric Kettles & Stands (KET, TKET Series)..... 13

Countertop Gas Kettles & Stands (KGT Series) 15

Floor Model Gas Kettles Stationary (KGL Series) 16

Floor Model Gas Kettles, Tilting (KGL-T Series) 18

Floor Model Electric Kettles, Stationary (KEL Series) 20

Floor Model Electric Kettles, Tilting (KEL-T Series) 21

Countertop Direct Steam kettles, Modular Stands (KDT-T Series, SD Series) 22

Floor Model Direct Steam Kettles, Stationary (KDL Series) 23

Floor Model Direct Steam Kettles, Tilting (KDL-T Series) 25

Kettle Accessories 27

Mixer Kettles, Vertical Sweep & Fold Series, Direct Steam (MKDL Series)..... 30

TILT SKILLETS

Countertop Electric (SET10, SET15)..... 31

Floor Model "Durapan" Series (SEL-SGL-TR Series) 32

Floor Model, Power Pan, (SEL-SGL-T1 Series) 33

Tilting Skillet Accessories 34

PRODUCT REFERENCE SECTION

Model Number Legend..... 35

THE CLEVELAND ADVANTAGE – KEY PRODUCTS AND FEATURES

Steamers

 SteamCraft 3/5, Gemini 10 Feature Callouts 36

 SteamChef Boilerless Convection Steamers (22CET, 22CGT, 22CCT Series)..... 37

 SteamChef Patented KleanShield (22CET, 22CGT, 22CCT Series) 38

 SteamCraft 3/5 Steamers (21CET8, 21CET16)..... 39

 Gemini 10 Pan Convection Steamer (24CGA10.2)..... 40

 Classic Line Steamers (24CGM, 24CEM Series)..... 41

 Steamer Warranty 42

Steam Jacketed Kettles

 Gas and Electric Feature Kettle Callouts (KEL, KGL Series) 43

 Benefits of Steam Jacket Kettle Cooking 44

 Countertop Steam Jacketed Kettles (KET, TKET-T Series) 45

THE CLEVELAND ADVANTAGE – KEY PRODUCTS AND FEATURES (CONTINUED)

Steam Jacketed Kettles

- Gas Floor Model Steam Jacketed Kettles (KGL Series)46
- Guide to Kettle Drain Valves47
- Swing Drain Funnels48
- Pan Carriers (PCK) and Flow Diverters (FD) for Tilting Kettles49

Tilting Skillets

- SGL-T1 Series Features Callouts50
- DuraPan - TR Series Tilt Skillets (SGL, SEL-TR)51
- PowerPan, T1 Series Tilt Skillets (SEL, SGL-T1).....52

EASYDIAL CONTROLS for Self-Contained Tilting Kettles, T1 Series Tilt Skillets53

CORRECTIONAL PACKAGES54

MARINE SHIPBOARD PACKAGES.....56

TECHNICAL INFORMATION

- Recommend Pipe Capacity for Direct Steam Kettles57
- Recommended Piping Schematic for direct Steam Kettles.....57
- Steam Requirement Data - Boiler Sizing Information.....58
- Steam Flow Rates for Direct Steam Kettles58
- Pressure Temperature Chart58
- Kettle and Tilt Skillet Capacity Serving Calculator.....59
- Energy Star and LEED information for Steamers60

STATEMENT OF POLICIES.....61

WARRANTY & EXTENDED WARRANTY PROGRAM.....62

STEAMER INSTALLATION PROGRAM.....64

WATER TREATMENT SELECTION GUIDELINES66

QUICK SHIP PROGRAM.....67

SHIPPING WEIGHTS, DIMENSIONS, CUBIC FEET, FREIGHT CLASS68



COOK CHILL AND SPECIALIZED EQUIPMENT

- Mixer Kettle, Vertical Sweep and Fold, Direct Steam71
- Mixer Kettle, Vertical Sweep and Fold, Electric72
- Mixer Kettle, Vertical Sweep and Fold, Gas73
- HA Mixer Kettle, Self-Contained Gas74
- HA Mixer Kettle, Direct Steam.....75
- HA Mixer Kettle, Self-Contained Electric77
- Pasta Kettles, Direct Steam78
- Food Pumps, Vacuum Sealing Machines.....79
- TurboJet Chillers, Product Chillers, and Cook Tanks80
- Compressed Air Systems, Hoist & Rail Systems82
- Mixer Kettle Variety84
- Cook Chill For Pumpable Products.....85
- Cook Chill Vertical Mixers86
- Self-Contained Cook System87

STEAMCHEF CONVECTION STEAMERS, ELECTRIC BOILERLESS

STEAMCHEF BOILERLESS CONVECTION STEAMERS WITH KLEANSHIELD

STEAMCHEF® Convection Steamer, Electric Boilerless 208-240 Volt 3 Phase, 60 Minute Electro-Mechanical Timer & Manual (Continuous Steaming) Bypass Switch, Surecook Load Compensating Timer, Self Adjusting Two-Piece Compartment Door, Patented KleanShield Compartment Design Eliminates Flavor Transfer, Door Steam Shut Off Switch, Capacity For Three Or Six 12" X 20" X 2.5" Pans, Heavy 14 Gauge Stainless Steel Construction, 4" Adjustable Legs, Meets Energy Star®, UL & NSF Certification

PRODUCT SERIES	MODEL	DESCRIPTION	SHIP WT LBS/KGS	LIST PRICE
ELECTRIC CONNECTIONLESS, 208-240 VOLT, 3 PHASE STANDARD				
	22CCT6	6-Pan SteamChef Electric Connection-less Convection Steamer With KleanShield	335/153	\$10,924
	(2)22CCT66	Two 22CCT6 with 113130SC stacking stand with KE004073 Mounting Kit		\$24,575
	22CCT62082403C	Model 22CCT6, 204-240 Volt, 3 Phase, 8 Foot Long Cord, 15-50 Plug Connector		\$10,924
	113130SC	Stacking Stand for (2)22CCT6, Mounting Kit (KE004073) Included		\$2,727
	KE004074	Mounting Kit For Single Unit 22CCT6 (Required For Mounting To Unistand34)		\$0
ELECTRIC CONNECTED 208-240 VOLT, 3 PHASE STANDARD				
	22CET3.1	3-Pan Electric Boilerless Convection Steamer (Drain And Water Connection Required)	235/107	\$10,447
	22CET6.1	6-Pan Electric Boilerless Convection Steamer (Drain And Water Connection Required)	335/153	\$13,558
	(2) 22CET33.1	(2) 22CET3.1 Direct Stacked on Stand UNISTAND25, Mounting Kit (111771) Included		\$22,283
	(2) 22CET63.1	(1) 22CET3.1, (1) 22CET6.1 Stacked With 111467E Stacking Stand (P/N 111467E)		\$26,552
	(2) 22CET66.1	(2) 22CET6.1 Stacked With 111467E Stacking Stand		\$29,506
	KE004289	Mounting Kit Required for Single Unit (22CET3,1 22CET6.1)		\$0
	111771	Stacking Mounting Kit for stacking two 22CET3.1 Steamchef (Direct Stack) on stacking stands, requires UNISTAND25, included water and drain plumbing manifold		\$0
OPTIONS (BUILT ON AT FACTORY)				
ELEVATION		Specify elevation over 3,500 feet		\$0
SPH		Single Phase Option		\$0
VOS2		440-480 volt option		\$610
DHR		Door Hinged Right, Controls On The Left , (22CET3.1, 22CET6.1 Only)		\$503
1114941		Right Side Heat Shield For 22CET3.1 - 3 Pan SteamChef		\$830
ACCESSORIES AND WATER FILTERS				
NHT60		5 Foot Long FDA Garden Hose Style Water Connection (2 Required - P/N 110999)		\$223
SPW		Single Point Water Connection (P/N 111009) Not Available On Stacked Units		\$221
110832		Additional Pan Rack Guides (Set) for 6 Pan Steamer		\$375
41423		Additional Pan Rack Guides (Set) For 3 Pan Steamer		\$514
FLT0001		Water Quality Test Kit (1150360)		\$36
FLT0040		Optipure Water Filter (WBT-QT11-CR)	12/6	\$571
FLT0043		Optipure High Hardness Water Filter (WBT-QTSX-2PG)		\$672
EQUIPMENT STANDS				
UNISTAND25		25" High Equipment Stand for Single Unit (P/N 111717)		\$1,957
UNISTAND34		34" High Equipment Stand for Single Unit (P/N 111721)		\$1,957
111467E		Stacking Stand for 22CET3.1 with a 22CET6.1, Mounting Kit (111170) Incuded		\$2,727
CHEFSTACK3		Stack Kit (Spacer , Water, Drain Kit) For Two 3-Pan SteamChef's (Unistand25 Required) (PN 111771)		\$758
113101-CLE		5" Braking Casters for SteamChef Equipment Stands, set of 4		\$101
POSK		Pull Out Shelf Kit for Unistand (P/N 111724)		\$526
URK		Pan Rack Kit for Unistand (P/N 111726)		\$298

22CCT6

22CET6.1

22CET3.1

22CET3.1 & UNISTAND25

UNISTAND25

STEAMCHEF CONVECTION STEAMERS, GAS BOILERLESS

GAS STEAMCHEF BOILERLESS CONVECTION STEAMERS WITH KLEANSHIELD

STEAMCHEF® Convection Steamer, Gas Boilerless, 32,000 BTU'S, 60 Minute Electro-Mechanical Timer & Manual (Continuous Steaming) Bypass Switch, Surecook Load Compensating Timer, Self Adjusting Two-Piece Compartment Door, Patented KleanShield Compartment Design Eliminates Flavor Transfer, Door Steam Shut Off Switch, Capacity For Three Or Six 12" X 20" X 2.5" Pans, Heavy 14 Gauge Stainless Steel Construction, 4" Adjustable Legs, Meets Energy Star®, Certified to Applicable UL, CSA and NSF Standards

PRODUCT SERIES	MODEL	DESCRIPTION	SHIP WT LBS/KGS	LIST PRICE
GAS STEAMCHEF STANDARD WITH 115 VOLT, NATURAL GAS				
	22CGT3.1	3-Pan Gas Boilerless Convection Steamer (Drain And Water Connection Required)	255/116	\$12,633
	22CGT6.1	6-Pan Gas Boilerless Convection Steamer (Drain And Water Connection Required)	355/161	\$16,321
	(2) 22CGT33.1	(2) 22CGT3.1 Stacked With 113131G Stacking Stand Connected		\$28,513
	(2) 22CGT63.1	(1) 22CGT3.1, (1) 22CGT6.1 Stacked With 113130G Stacking Stand		\$31,994
	(2) 22CGT66.1	(2) 22CGT6.1 Stacked With 113130G Stacking Stand		\$35,326
	113131G	Stacking Stand for (2) 22CGT33.1, Mounting Kit (113124) included		
	KE004289	Mounting Kit Required For Single Unit 22CGT3.1 & 22CGT6.1 On Stand		\$0
	113124	Mounting Kit for stacking two 22CGT SteamChef units on stacking stands, Mouting Kit included with stand (113130G)		\$0
	22CGT6.1			
OPTIONS				
	ELEVATION	Specify Elevation If Over 2,000 Feet For Gas Models		\$0
	LPG	L.P. Gas Option		\$0
ACCESSORIES				
	NHT60	5 Foot Long FDA Approved Garden Hose Style Water Connection (2 Required - P/N 110999)		\$233
	SPW	Single Point Water Connection (P/N 111009) Not Available On Stacked Units		\$221
	LPCK	Natural To LP Gas Conversion Kit For Gas SteamChef (P/N114678)		\$248
	PR	Additional Pan Rack Guides (Set) For 3 Pan (P/N 41423)		\$514
	110832	Additional Pan Rack Guides (Set) for 6 Pan		\$425
	114768	Natural to LP Conversion Kit 22CGT3.1/6.1, 2,000 Ft. Elevation, UL Certified		\$397
	114767	LP to Natural Conversion Kit 22CGT3.1/6.1, 2,000 Ft. Elevation, UL Certified		\$397
	113130G			
WATER FILTERS				
	FLT0040	Optipure Water Filter	12/6	\$571
	FLT0001	Water Quality Test Kit (1150360)		\$36
	FLT0043	Optipure High Hardness Water Filter (WBT-QTSX-2PG)		\$672
EQUIPMENT STANDS				
	UNISTAND34	34" High Equipment Stand For Single Unit (P/N 111721)	85/39	\$1,957
	UNISTAND25	25" High Equipment Stand For Single or Stacked Unit (P/N111717)	75/34	\$1,957
	113130G	Stacking Stand For Stacking Gas SteamChef (2)22CGT63.1 or (2)22CGT66.1, Mounting Kit (113124) Included	100/44	\$2,727
	113101-CLE	5" Casters with brakes (Set of 4) for SteamChef Equipment Stands		\$101
	POSK	Pull Out Shelf Kit For Unistands (P/N 111724)		\$526
	URK	Pan Rack Kit For Unistand (P/N 111726)		\$398

CONVECTION STEAMERS, COUNTER TOP, STAINLESS STEEL GENERATORS

STEAMCRAFT COUNTER TOP CONVECTION GENERATOR MODELS

SteamCraft® Generator Style Convection Steamer, 60 Minute Electro-Mechanical Timer & Manual (Continuous Steaming) Bypass Switch, Capacity For three or five 12" X 20" X 2.5" Pans, Self Adjusting Two-Piece Compartment Door, Auto Water Fill And Drain, Firebar Style Self Cleaning Heating Element With Special Low Watt Drying Element For Dry Steam (Electric Models), Steam Shut Off Door Switch, Heavy 14 Gauge Stainless Steel Construction, 4" Adjustable Legs Standard, Easy Access Descaling Port, Certified to Applicable UL, CSA and NSF Standards

PRODUCT SERIES	MODEL	DESCRIPTION	SHIP WT LBS/KGS	LIST PRICE
ELECTRIC & GAS MODELS AVAILABLE				
 21CET8	21CET8	3-Pan Convection Steamer with Electric Steam Generator, 8 Kw	210/50	\$9,135
	(2) 21CET8	(2) 21CET8 Stacked, Includes Stacking Kit And Stand 1054251, Field Assembled, 8 Kw	600/272	\$21,638
	21CET16	5-Pan Convection Steamer with Electric Steam Generator, 16 Kw	248/58	\$12,364
	21CGA5	5-Pan Convection Steamer with Gas Generator, 70,000 BTU's, Natural Gas, 115 Volt	275/125	\$17,729
	KE004289	Add Mounting Kit Required for Single Unit 21CET8 & 21CET16 on stand		\$0
	107166	Mounting Kit for stacking two 21CET8 SteamChef (Direct Stack) on stacking stands. Mounting Kit Included with UNISTAND25		\$0
 21CET16	OPTIONS (BUILT ON AT FACTORY)			
	VOS1	208 Or 240 Volt 3 Phase (Must Specify One On Electric Models)		\$0
 DISSOLVE	VOS2	440-480 Volt 3 Phase (Electric Models)		\$610
	SPH	Single Phase Option (21CET8 Only)		\$0
	DHR	Door Hinged Right, Controls On The Left (Not Available On 21CGA5)		\$503
	1114941	Heat Shield For 21CET8 Only Right Side		\$830
	LPG	LP Gas Option (21CGA5)		\$0
	ELEVATION	Gas Models Specify Elevation If Over 2,000 Feet		\$0
	CPCSG	Prison Packages, Tamper Proof Pan Racks, Tamper Proof Exterior Sheeting, Tamper Proof Descaling Port, Protective Cover for Controls, Hasp Lock by others. (See Page 53 for Details)		\$1,633
 BDPK1	ACCESSORIES			
	DISSOLVE	Dissolve Descaling Solution Case Of 6 - One Gallon Containers (106174)		\$362
	DTV15CLV	Drain Cooling Kit with 1-1/2" Drain Connection, 1-1/4" reducer included		\$1,363
	41423	Additional Pan Rack Guides- 3 Pan Models		\$514
	414232	Additional Pan Rack Guides (Set) for 5 Pan Models		\$514
	114771	LP to Natural Conversion Kit, 21CGA5, 2,000 Ft. Elevation, UL Certified		\$397
	114772	Natural to LP Conversion Kit, 21CGA5, 2,000 Ft. Elevation, UL Certified		\$397
	BDPK1	Boiler Descaling Pump Kit - For Generators With Descale Port (1071421)		\$999
	QDC60	60" Quick Disconnect Hose (Gas Models)(P/N 1007841)		\$902
	SPH1	Single Phase Conversion Kit For 21CET8 (P/N 104393)		\$1,053
 FLT0040, FLT0043	WATER FILTERS			
	FLT0040	QT11-CR Optipure Water Filter	12/6	\$571
	FLT0043	QTSX-2PG High Hardness Optipure Water Filter	12/6	\$672
	FLT0001	Water Quality Test Kit		\$36
 UNISTAND25	EQUIPMENT STANDS			
	UNISTAND34	34" High Equipment Stand (P/N 111721)	85/39	\$1,957
	UNISTAND25	25" High Equipment Stand Or Direct Stacking A 21CET8 (P/N 111717)	75/34	\$1,957
	POSK	Pull Out Shelf Kit For Unistands (P/N 111724)		\$526
	URK	Pan Rack Kit For Unistand (P/N 111726)		\$398
 1054251	1054251	Steamcraft Stacking Stand For Stacking Two 21CET8, Or Two 21CET16 (Not Available On 21CGA5)	77/34	\$3,323

CONVECTION STEAMERS, 10 PAN, STAINLESS STEEL GENERATORS

10-PAN CONVECTION STEAMERS — FLOOR MODEL WITH GENERATORS

Steamcraft® 10 Convection Steamer, 2 Compartment Generator Style Steamer. Turbo Charged Forced Air Gas Combustion Design (Gas Models) Capacity For Ten 12" X 20" X 2.5" Pans, 60-Minute Electro-Mechanical Timer & Manual (Continuous Steaming) Bypass Switch, Self Adjusting Two-Piece Compartment Door, Door Steam Shut Off Switch, Heavy Gauge Stainless Steel Construction, 6" Level Adjustable Flanged Feet, Easy Access Descaling Port, Certified to Applicable UL, CSA and NSF Standards

PRODUCT SERIES	MODEL	DESCRIPTION	SHIP WT LBS/KGS	LIST PRICE
GAS, ELECTRIC, DIRECT STEAM MODELS AVAILABLE				
	24CGA6.2S	6-Pan Convection, Gas Gemini Series Twin Generator, 50M BTU's Each	565/256	\$27,802
	24CGA10	10-Pan Convection, Gas Single Generator, 125M BTU	565/256	\$25,651
	24CGA10.2	10-Pan Convection, Gas Gemini Series Twin Gas Generator 72M BTU'S Each	565/256	\$28,285
	24CGA10.2ES	10-Pan Convection, Gas Gemini Series Twin Gas Generator 50M BTU'S Each Meets Energy Star	565/256	\$31,669
	24CGP10	10-Pan Convection, Gas 15 PSI Gas Boiler, 240M BTU	830/376	\$40,597
	24CEA10.2	10-Pan Convection, Electric Gemini Series Twin Generator, 16 Kw Each	528/240	\$26,785
	24CDP10	10-Pan Convection, Direct Steam (Must Use Clean Potable Steam Source, 20 - 50- PSI Incoming Required)	495/224	\$25,382
OPTIONS (BUILT ON AT FACTORY)				
	ELEVATION	Gas Models Specify Elevation If Over 2,000 Feet		\$0
	LPG	LP - Propane Gas (Gas Models)		\$0
	FF	Level Adjustable Flanged Feet For Floor Bolting Standard with Unit		STD
	VOS1	208 Or 240 Volt 3 Phase (Must Specify One 24CEA10 Only)		\$0
	VOS22	440-480 Volt 3 Phase (24CEA10 Only)		\$609
	LWO	Low Wattage Option 8 Kw Per Compartment (24CEA10 Only)		\$122
	113716	Heat Shield For 24CGA10.2, 24CEA, 24CGP10, Right Side only		\$1,311
	113717	Heat Shield for 24CGA10.2 Right Side only		\$1,311
	CPSCG	Prison Packages, Tamper Proof Pan Racks, Tamper Proof Exterior Sheeting, Tamper Proof Descaling Port, Protective Cover for Controls, Hasp Lock by others. (See Page 53 for Details)		\$1,960
ACCESSORIES				
	DISSOLVE	Dissolve Descaling Solution 6 - One Gallon Containers (106174)		\$362
	BDPK	Boiler Descaling Pump Kit - For 15 PSI Boiler Models (24CGP10 Only) (PN 107142)		\$999
	BDPK1	Boiler Descaling Pump Kit - For Generators With Descale Port (1071421)		\$999
	QDC60	5 Foot Long 3/4" Long Gas Quick Disconnect Hose, Gas Models Only (P/N 1007841)		\$902
	GPTO10	Gas Power Take Off Kit To Operate Direct Steam Kettles (P/N 40946 - 24CGP10 Only)		\$523
	IMK6	6 Foot Long Kettle Interconnect Hose (409351) Requires Power Take Off Kit (Model 24CGP10 Only)		\$448
	IMK10	10 Foot Long Kettle Interconnect Hose (409355) Requires Power Take Off Kit (Model 24CGP10 Only)		\$619
	IMK15	15 Foot Long Kettle Interconnect Hose (409358) Requires Power Take Off Kit (Model 24CGP10 Only)		\$780
	DTV15CLV	Drain Cooling Kit with 1-1/2" drain connection, 1-1/4 reducer included for all steamers except 24CGA10.2ES		\$1,363
	DTV20CLV	Drain Cooling Kit with 2.0" drain connection for 24CGA10.2 Only		\$1,363
	114594	Natural to LP Conversion Kit, 24CGA6.2, 24CGA6.2ES, 24CGA10.2ES, (P/N 114594)		\$397
	114569	Natural to LP Conversion Kit, 24CGA10.2, 2,000 Ft. Elevation, UL Certified		\$397
	114774	Natural to LP Conversion Kit, 24CGA10.2, 2,000 Ft. Elevation, UL Certified		\$397
	114776	Natural to LP Conversion Kit, 24CGP10, 2,000 Ft. Elevation, UL Certified		\$397
	114775	LP to Natural Conversion Kit, 24CGP10, 2,000 Ft. Elevation, UL Certified		\$397
WATER FILTERS				
	FLT0040	QT11-CR Optipure Water Filter		\$571
	FLT0043	QTSC-2PG High Hardness Optipure Water Filter		\$672
	FLT0001	Water Quality Test Kit		\$36

24CGA10



DISSOLVE



BDPK1



IMK10

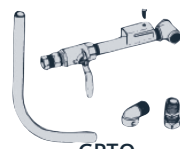

GPTO



FLT0040 & FLT0043

CONVECTION & PRESSURE STEAMERS, BOILER BASE (15 PSI)

CLASSIC LINE STEAMERS — BOILER BASE STEAMERS





Cleveland Classic Convection & Pressure Steamers, 15 PSI Boiler Base (Gas, Electric, Steam Coil) Steamer With 5-Year Prorated Boiler Warranty, Heavy 14 Gauge Stainless Steel Construction, 6" Level Adjustable Flanged Feet, Heavy Stainless Steel Frame, 60 Minute Mechanical Timer, Certified to Applicable UL, CSA and NSF Standards

PRODUCT SERIES	MODEL	DESCRIPTION	SHIP WT LBS/KGS	LIST PRICE	
6 - PAN CONVECTION, ELECTRIC, GAS, DIRECT STEAM, STEAM COIL MODELS AVAILABLE					
	24CGM200	6-Pan Convection Steamer, 200M BTU Gas 15 PSI Boiler, 24" Wide Base	610/277	\$36,046	
	24CEM24	6-Pan Convection Steamer, Electric 24Kw 15 PSI Boiler, 24" Wide Base	530/240	\$34,633	
	24CSM	6-Pan Convection Steamer, Steam Coil 15 PSI Boiler, 24" Wide Base	635/288	\$38,684	
	36CGM300	6-Pan Convection Steamer, 300M BTU Gas 15 PSI Boiler, 36" Wide Base	755/342	\$40,789	
16 - PAN CONVECTION, ELECTRIC, GAS, DIRECT STEAM, MODELS AVAILABLE					
	36CGM16300	16-Pan Convection Steamer, 300M BTU Gas 15 PSI Boiler, 36" Wide Base	1080/499	\$48,549	
	36CEM1648	16-Pan Convection Steamer, Electric 48Kw 15 Boiler, 36 Wide Base	1080/499	\$40,299	
	36CDM16	16-Pan Convection Steamer, Direct Steam (Requires Clean Steam, 35-50 PSI), 36" Base	1080/499	\$32,530	
2 & 3 COMPARTMENT PRESSURE STEAMERS, ELECTRIC, GAS, DIRECT STEAM					
	PEM242	2-Compartment Pressure Steamer, 24Kw Electric 15 PSI Boiler, 36" Wide Base	830/426	\$38,631	
	PEM243	3-Compartment Pressure Steamer, 24Kw Electric 15 PSI Boiler, 36" Wide Base	830/426	\$39,932	
	PGM3002	2-Compartment Pressure Steamer, 300M BTU Gas 15 PSI Boiler, 36" Wide Base	874/397	\$42,024	
	PGM3003	3-Compartment Pressure Steamer, 300M BTU Gas 15 PSI Boiler, 36" Wide Base	1040/472	\$50,215	
	PDL2	2-Compartment Pressure Steamer, Direct Steam, 36" Wide Base	510/231	\$23,246	
	PDL3	3-Compartment Pressure Steamer, Direct Steam, 36" Wide Base	600/272	\$30,527	
OPTIONS					
	FF	Level Adjustable Flanged Feet For Floor Bolting Standard		STD	
	LPG	LP Gas Option, Gas Models		\$0	
	ELEVATION	Gas Models Specify Elevation If Over 2,000 Feet		\$0	
	36KW	36Kw Option For Electric Boilers		\$1,098	
	48KW	48 Kw Option For Electric Boilers		\$2,242	
	VOS22	440-480 Volt, 60 Hz, 3 Phase (Electric Models Only)		\$554	
	PKO	PKO - Power Take Off Option For Pressure Steamers To Operate Kettles		\$1,240	
	114778	Natural to LP Conversion Kit, 200M BTU Boiler Base		\$397	
	114780	Natural to LP Conversion Kit, 300M BTU Boiler Base		\$397	
	CP-CCX	Prison Packages, Tamper Proof Pan Racks, Tamper Proof Exterior Sheeting, Tamper Proof Cabinet Base with Hasp, Protective Cover for Control with Hasp, Hasp Lock by others. (See Page 49 for Details)		\$1,938	
	COMMON ACCESSORIES (FOR DETAILED ACCESSORIES SEE PAGE 12)				
		GPTO	Power Take Off Kit For Gas Boilers - 6 Pan Convection Models Only (40946)		\$523
		EPTO	Power Take Off Kit For Electric Boilers 6 Pan Convection Models Only (40947)		\$518
IMK6		6 Foot Long Kettle Interconnect Kit (409351)		\$448	
IMK10		10 Foot Long Kettle Interconnect Kit (409355)		\$619	
IMK15		15 Foot Long Kettle Interconnect Kit (409358)		\$780	
DISSOLVE		Descaling Solution 6 - One Gallon Containers (106174)		\$362	
BDPK		Boiler Descaling Pump Kit - 15 PSI Boilers (107142)		\$999	
DTV15CLV		Drain cooling kit with 1-1/2" drain connection, 1-1/4" reducer included		\$1,363	
QDC60		5ft 3/4" long gas quick disconnect hose, gas models only 24CGM200, 36CGM300 Model (P/N 1007841)		\$902	
MS		Moisture Separator Trap for Direct Steam Models only (P/N 19020)		\$699	
PRV		Pressure Reducing Valve-Direct Steam Models only		\$1,138	
105994		Additional Pan rack set for pressure steamers, 1 set per compartment		\$423	
POS	Pull out shelves for pressure steamers, 1 set each compartment		\$526		
WATER FILTERS					
	FLT0040	Optipure Water Filter	12/6	\$571	
	FLT0043	High Hardness Optipure Water Filter	12/6	\$672	
	FTL0001	Water Quality Test Kit		\$36	

MODULAR BASES WITH KETTLES, BOILER BASE (15 PSI)

MODULAR BASES WITH KETTLES — BOILERS

Cleveland Classic Boiler Base, 15 PSI Boiler Base (Gas, Electric, Direct Steam) With 5-Year Prorated Boiler Warranty, Heavy 14 Gauge Stainless Steel Construction, 6" Level Adjustable Flanged Feet, Heavy Stainless Steel Frame, Full Width Drain Trough And Grate, Splash Guard, 6 & 10 Gallon Direct Steam Combinations, Double Pantry Faucet, 316 Stainless Steel Interior On Kettle, Certified to Applicable UL, CSA and NSF Standards

PRODUCT SERIES	MODEL	DESCRIPTION	SHIP WT LBS/KGS	LIST PRICE	
 36EMK6624	24EMK624	One 6-Gallon Kettle, 24Kw 15-PSI Boiler	565/256	\$24,884	
	36EMK6624	Two 6-Gallon Kettles, 24Kw 15-PSI Boiler	610/276	\$36,841	
	24GMK6200	One 6-Gallon Kettle, 200M BTU Gas 15-PSI Boiler	565/256	\$28,565	
	36GMK66300	Two 6-Gallon Kettles, 300M BTU Gas 15-PSI Boiler	630/286	\$40,125	
	36GMK1010300	Two 10-Gallon Kettles, 300M BTU Gas 15-PSI Boiler	630/286	\$41,648	
	24DMK6	One 6-Gallon Kettle, Direct Steam	565/256	\$15,185	
	36DMK66	Two 6-Gallon Kettles, Direct Steam	630/286	\$25,368	
	36DMK1010	Two 10-Gallon Kettles, Direct Steam	630/286	\$28,079	
	24GM200	200M BTU Gas 15-PSI Boiler Base	465/210	\$19,226	
	36GM300	300M BTU Gas 15-PSI Boiler Base	520/235	\$23,514	
 24GM200	24EM24	24 Kw Electric 15-PSI Boiler Base	390/176	\$15,974	
	OPTIONS				
	FF	Level Adjustable Flanged Feet For Floor Bolting Standard			\$0
	36KW	36Kw Option For Electric Boilers			\$1,098
	48KW	48 Kw Option For Electric Boilers			\$2,242
	VOS1	208 Or 240 Volt 3 Phase (Electric Models Only)			\$0
	VOS22	440-480 Volt, 60 Hz, 3 Phase (Electric Models Only)			\$609
	LPG	LP Gas Option (Gas Models)			\$0
	ELEVATION	Gas Models Specify Elevation If Over 2,000 Feet			\$0
	COMMON ACCESSORIES (FOR DETAILED ACCESSORIES SEE PAGE 12)				
 24EM24	GPTO	Power Take Off Kit For Gas Boilers - (40946)		\$523	
	EPTO	Power Take Off Kit For Electric Boilers (40947)		\$518	
	IMK6	6 Foot Long Kettle Interconnect Kit (409351)		\$448	
	IMK10	10 Foot Long Kettle Interconnect Kit (409355)		\$619	
	IMK15	15 Foot Long Kettle Interconnect Kit (409358)		\$780	
	DISSOLVE	Descaling Solution 6 - One Gallon Containers (106174)		\$362	
	BDPK	Boiler Descaling Pump Kit - 15 PSI Boilers (107142)		\$999	
	QDC60	5 Foot 3/4" Long Gas Quick Disconnect Hose, Gas Models Only 24CGM200, 36CGM300 Models (P/N 1007841)		\$902	
	DTV15CLV	Drain Cooling Kit with 1-1/2" drain connection, 1-1/4 reducer included for all steamers except 24CGA10.2ES		\$1,363	
	WATER FILTERS				
 FLT0040, FLT0043	FLT0040	Optipure Water Filter	12/6	\$571	
	FLT0043	High Hardness Optipure Water Filter	12/6	\$672	
	FLT0001	Water Quality Test Kit		\$36	

WATER FILTERS

PRODUCT SERIES	MODEL	DESCRIPTION	SHIP WT LBS/KGS	LIST PRICE
----------------	-------	-------------	--------------------	---------------



FLT0040



FLT0043

STANDARD FILTERS

FLT0040	Optipure Water Filter #160-52081 (QT11+CR)	12/6	\$571
FLT0014	Replacement Cartridge #300-05828 (1 Required)		\$113
FLT0018	Replacement Cartridge #300-05831 (1 Required)		\$163
FLT0001	Water Quality Test Kit		\$36

HIGH HARDNESS WATER FILTERS (+170 PPM)

FLT0043	Optipure Water Filter #160-52822	12/6	\$672
FLT0015	Replacement Cartridge #300-05830 (1 Required)		\$108
FLT0044	Replacement Cartridge (1 Required)		\$205
FLT0001	Water Quality Test Kit		\$36

CLEVELAND WATER QUALITY REQUIREMENTS

TDS	50-250 PPM
HARDNESS	50-200 MM (3-12 GPG); NOTE USE HARD WATER FILTER IF ABOVE 170PPM
PH VALUE	7.0-8.5
CL (CHLORIDE)	MAX 50 PPM
CL2 (FREE CHLORINE)	MAX 0.1 PPM
FE (IRON)	MAX 13 PPM
SIO2 SILICA	35-80 PSI

MISCELLANEOUS STEAMER ACCESSORIES

PRODUCT SERIES	MODEL	DESCRIPTION	SHIP WT LBS/KGS	LIST PRICE
MISCELLANEOUS STEAMER ACCESSORIES				
QDC60		5 Foot long 3/4" Long Gas Quick Disconnect Hose, Gas Models Only 24CGM200, 36CGM300 Models (P/N 1007841)		\$902
MS		Moisture Separator Trap (P/N 19020)		\$699
PRV		Pressure Reducing Valve		\$1,138
TRF		Step Down Transformer (P/N 107040)		\$697
PP25		2.5" 12" X 20" Perforated Pan (P/N 16868)		\$294
PP4		4" X 12" X 20" Perforated Pan (P/N 16854)		\$343
SP25		2.5" X 12" X 20" Solid Pan (P/N 16869)		\$276
NHT60		5 Foot Garden Hose Style Water Connection Kit (P/N 110999)		\$223
LF4		4" Adjustable Legs Standard (P/N 2501018) Price Each		\$28
LF41		4" Legs For Counter Top Steamers (1 Ea) 21CGA5 (P/N 2501018)		\$28
LF42		4" For Counter Top Steamers (1 Ea) Steamcraft 21CET8 (Black) (P/N 1014501)		\$28
LF43		4" Legs For Counter Top Steamers (1 Ea) Steamchef (P/N 1110021)		\$28
LF6		6" Legs For Counter Top Steamers (1 Ea) SteamCub (P/N 115328)		\$28
LF10		10" Legs for Floor Model Steamers (Pan 111288)		\$28
100413		Flanged Foot for equipment stands (each)		\$65
113101-CLE		5" Casters for ES Series Equipment Stands for steamers (One each with break)		\$101
69615		Splash Guard for 24, 36" Modular bases		\$53

KETTLES, COUNTER TOP, ELECTRIC

COUNTER TOP ELECTRIC KETTLES

Cleveland Self Contained Counter Top Kettles, Electric Models Standard 208 - 240 Volt, 3 Phase (Field Convertible To 1 Phase), 50 PSI Steam Jacket Rating, Solid state temperature control, 316 Stainless Steel Interior, IPX6 Water Rated, 2/3 Steam Jacket, EDC Controls (Cook ON, Cook OFF, Cook HOLD, & Product Probe cooking features), Built In Diagnostics, Reinforced Rolled Rim, Marine Style Self Locking Safety Latch, 1 - 10 Steam Control Dial, Low Water LED Indicator, Color Coded Pressure Vacuum Gauge, Certified to Applicable NSF Standards, and CE Certification

PRODUCT SERIES	MODEL	DESCRIPTION	SHIP WT LBS/KGS	LIST PRICE
----------------	-------	-------------	-----------------	------------

ELECTRIC MODELS

KET3T	3 Gallon (11 Liter) Electric, Tilting With Standard Controls	95/43	\$7,566
KET6T	6 Gallon (23 Liter) Electric, Tilting With Standard Controls	160/73	\$8,448
KET6TGB	6 Gallon (23 Liter) Electric, Gear Box Style Tilting With Standard Controls	170/77	\$10,966
KET12T	12 Gallon (45 Liter) Electric, Tilting With Standard Controls	180/82	\$10,222
KET12TGB	12 Gallon (45 Liter) Electric Gear Box Style Tilting With Standard Controls	190/86	\$11,847
KET20T	20 Gallon (90 Liter) Electric, Tilting (Floor Model) With Standard Controls	260/118	\$16,275
KE003874	Field Installed Drain Drawer (For KET20T only)		\$619
TKET3T	Twin 3 (11 Liter Ea) Gallon Electric, Tilting With Standard Controls	135/60	\$16,843
TKET6T	Twin 6 (23 Liter Ea) Gallon Electric, Tilting With Standard Controls	226/103	\$20,243
TKET12T	Twin 12 (45 Liter Ea) Gallon Electric, Tilting With Standard Controls	315/143	\$25,520

EASYDIAL CONTROL OPTION (BUILT ON AT FACTORY)

EZD	EasyDial Control Option (Not Available On TKET'S)		\$1,111
TCP1	Core Temperature Probe, EasyDial Controls Only (Not Available On TKET'S) (KE604132-1)		\$731

OPTIONS (BUILT ON AT FACTORY)

ELEVATION	Specify Elevation If Over 3,000 Feet Electric Models		\$0
KM1G	Kettle Gallon Markings - 1 Gallon Increments (Use KM1L Liters Increments)		\$758
HW1	High Wattage Option (6,12, 20 KET Electric Models)		\$0
HW20	High Wattage Option (KET20T Electric Models)		\$0
VOK1	380 Or 415 Volt, 50 Hz, 3 Phase For Electric Export (N/A On KET3T)		\$709
VOK2	440/480 Volt, 60 Hz, 3 Phase (N/A On KET3T)		\$1,261
PCE	Protective Control Cover		\$337
CP-KTTT	Correctional Package For Counter Top Electric Kettles		\$1,177

COUNTER TOP KETTLE ACCESSORIES

CL-3	Lift Off Cover With Build In Condensate Seal		\$512
CL-6	Lift Off Cover With Build In Condensate Seal		\$512
CL-12	Lift Off Cover With Build In Condensate Seal		\$664
CL-20	Lift Off Cover With Build In Condensate Seal		\$702
LCH-3	Lift Off Cover Holder for KET3T (KE003927-3)		\$249
LCH-6	Lift Off Cover Holder for KET6T (KE003927-2)		\$249
LCH-12	Lift Off Cover Holder for KET12T (KE003927-1)		\$249
LCH-20	Lift Off Cover Holder for KET20T (KE003927-4)		\$249
DPK28	Double Pantry Faucet/Bracket for KET20T		\$776
SPK28	Single Pantry Faucet/Bracket for KET20T		\$600
DPK27	Double Pantry Faucet/Bracket for KET3/6/12T, TKET3/6/12T		\$776
SPK27	Single Pantry Faucet/Bracket for KET3/6/12T, TKET3/6/12T		\$600
FS-3	3 gal Food Strainer		\$427
FS-6	6 gal Food Strainer		\$427
FS-12	12 gal Food Strainer		\$427
FS-20	20 gal Food Strainer		\$427
BS-3	3 gal Basket Stainless Steel Cooking Basket		\$932
BS-6	6 gal Basket Stainless Steel Cooking Basket		\$984
BS-12	12 gal Basket Stainless Steel Cooking Basket		\$1,241
KAK	Kettle Accessory Kit (P/N 40880) Includes items below from KBK to KL		\$1,572
KBK	Kettle Brush Kit (P/N 408802)		\$568
CB	Clean Up Brush (P/N 00856)		\$146
KP	Kettle Paddle (P/N 102405)		\$260
KW	Kettle Whip (P/N 00961)		\$521
KB	Kettle Brush (P/N 00853)		\$244
DB	Draw off Brush (P/N 00852)		\$146
KL	Kettle Ladle (P/N 00904)		\$420



KET12T



KET12TGB



KET20T



EZD



CL3



FS12



KAK

**ST SERIES
EQUIPMENT STANDS**

Heavy Stainless Steel Construction With 1-1/4" Square Tubing, Adjustable Feet, (Rear Flanged Feet For Bolting To Floor) Standard With Sliding Drain Drawer And Splash Screen, Can Be Hard Piped To Floor Drain, UL197, NSF-4 Certification



EST28G



ST28G



ST55G

ACCESSORIES (CONT.)

SKFK	Single Pantry Kettle Filler (P/N 105978)	\$1,386
DKFK	Double Pantry Kettle Filler (P/N 105979)	\$1,667





EQUIPMENT STANDS

EST28G	28" Economy Equipment Stand, No Drain Drawer For Single Kettle	28/13	\$1,569
ST28G	28" Wide Equipment Stand W/ Drain Drawer And Splash Screen For Single Kettle	35/16	\$2,376
ST42G	42" Wide Equipment Stand W/ Drain Drawer And Splash Screen (TKET3T, TKET6T)	65/29	\$4,510
ST55G	55" Wide Equipment Stand W/ Drain Drawer And Splash Screen (For (2) KET3T, KET6T, KET12T, SET10, SET15, KDT3, KDT6T, KDT12T)	70/32	\$4,854
ST55T	55" Wide Equipment Stand W/ Drain Drawer And Splash Screen (For (1) TKET12T)	70/32	\$4,854
SG-28G	Large Flow Folding Splash Guard For ST28, ST55		\$280
SG-42G	Large Flow Folding Splash Guard For ST42 Equipment Stand		\$253

KETTLES, COUNTER TOP, GAS

COUNTER TOP GAS KETTLES

Cleveland Self Contained Counter Top Kettles, Gas Models Standard With 120 Volt With Cord & Plug, 50 PSI Steam Jacket Rating, 316 Stainless Steel Interior, 2/3 Steam Jacket, EDC Controls (Cook ON, Cook OFF, Cook HOLD, & Product Probe cooking features), Built In Diagnostics, Reinforced Rolled Rim, Marine Style Self Locking Safety Latch, 1 - 10 Steam Control Dial, Low Water LED Indicator, Color Coded Pressure Vacuum Gauge, Certified to Applicable CSA and NSF Standards

PRODUCT SERIES	MODEL	DESCRIPTION	SHIP WT LBS/KGS	LIST PRICE	
GAS MODELS					
	KGT6T	6 Gallon (23 Liter) Gas Tilting With Standard Controls	130/59	\$15,348	
	KGT12T	12 Gallon (45 Liter) Gas Tilting With Standard Controls	190/86	\$18,241	
	KGT12TGB	12 Gallon (45 Liter) Gas Gear Box Style Tilting With Standard Controls	215/98	\$20,228	
	EASYDIAL CONTROL OPTION				
	EZD	EasyDial Control Option		\$1,111	
	TCP1	Core Temperature Probe, EasyDial Controls Only (KE604132-1)		\$731	
	ADDITIONAL OPTIONS				
	ELEVATION	Specify Elevation If Over 2,000 Feet Gas Models		\$0	
	LPG	LP Gas Option (KGT Series)		\$0	
	KM1G	Kettle Gallon Markings - 1 Gallon Increments (Use KM1L for Liter Increments))		\$758	
	VOK1G	220 Volt, 50 Hz, 1 Phase (KGT Series For Export)		\$749	
	PCE	Protective Control Cover		\$337	
	CP-KTTT	Correctional Package For Counter Top Electric Kettles		\$1,043	
	COMMON ACCESSORIES (FOR MORE ACCESSORIES SEE ALL KETTLE ACCESSORIES PAGE 22-24)				
		CL-6	Lift Off Cover With Build In Condensate Seal		\$512
CL-12		Lift Off Cover With Build In Condensate Seal		\$664	
DPK28		Double Pantry Faucet /Bracket		\$776	
SPK28		Single Pantry Faucet /Bracket		\$600	
SKFK		Single Pantry Kettle Filler (P/N 105978)		\$1,386	
DKFK		Double Pantry Kettle Filler (P/N 105979)		\$1,667	
PRSK		Pre-Rinse Spray Hose (P/N B-0113)		\$1,734	
LCH-6G		Lift Off Cover Holder KGT6T (KE003980-2)		\$249	
LCH-12G		Lift Off Cover Holder KGT12T (KE003980-1)		\$249	
FS-6GAS		Food Strainer For 6 Gallon Gas Kettle		\$427	
FS-12GAS		Food Strainer For 12 Gallon Gas Kettle		\$427	
QDC60		5 Foot Long 3/4" Long Gas Quick Disconnect Hose (P/N 1007841)		\$1902	
KAK		Kettle Accessory Kit (P/N 40880) Includes items below from KBK to KL		\$1,572	
KBK		Kettle Brush Kit (P/N 408802)		\$568	
CB		Clean Up Brush (P/N 00856)		\$146	
KP		Kettle Paddle (P/N 102405)		\$260	
KW		Kettle Whip (P/N 00961)		\$521	
KB	Kettle Brush (P/N 00853)		\$244		
DB	Draw off Brush (P/N 00852)		\$146		
KL	Kettle Laddle (P/N 00904)		\$420		
BS-6	6 gal basket stainless steel		\$984		
BS-12	12 gal basket stainless steel		\$1,241		

ST SERIES EQUIPMENT STANDS

Heavy Stainless Steel Construction With 1-1/4" Square Tubing, Adjustable Feet, (Rear Flanged Feet For Bolting To Floor) Standard With Sliding Drain Drawer And Splash Screen, Can Be Hard Piped To Floor Drain, UL197, NSF-4 Certification

PRODUCT SERIES	MODEL	DESCRIPTION	SHIP WT LBS/KGS	LIST PRICE
	EST28G	28" Economy Equipment Stand, No Drain Drawer For Single Kettle	28/13	\$1,569
	ST-28G	28" Wide Equipment Stand W/ Drain Drawer And Splash Screen For Single Kettle	35/16	\$2,376
	ST-42G	42" Wide Equipment Stand W/ Drain Drawer And Splash Screen (For Two KGT6T)	65/29	\$4,509
	ST55G	55" Wide Equipment Stand W/ Drain Drawer And Splash Screen (For Two KGT12T)	70/32	\$4,854
	SG28G	Large Flow Folding Splash Guard For ST28, ST55		\$275
	SG42G	Large Flow Folding Splash Guard For ST42 Equipment Stand		\$253
	100413	Flanged Foot for equipment stands (Set of 4)		\$275

GAS FLOOR MODEL — STATIONARY

KETTLES, GAS FLOOR MODEL — STATIONARY

Cleveland Self Contained Counter Top Kettles, Gas Models Standard With 120 Volt With Cord & Plug, 50 PSI Steam Jacket Rating, 316 Stainless Steel Interior, 2/3 Steam Jacket, EDC Controls (Cook ON, Cook OFF, Cook HOLD, & Product Probe cooking features), Built In Diagnostics, Reinforced Rolled Rim, Marine Style Self Locking Safety Latch, 1 - 10 Steam Control Dial, Low Water LED Indicator, Color Coded Pressure Vacuum Gauge, Certified to Applicable CSA and NSF Standards.

PRODUCT SERIES	MODEL	DESCRIPTION	SHIP WT LBS/KGS	LIST PRICE
STATIONARY MODELS - STANDARD WITH 2" TANGENT DRAW-OFF AND SPRING ASSIST COVER				
 <p>KGL40</p>	KGL25	25 Gallon (95 Liter) Gas Kettle, 2" Tangent Draw-Off And Spring Assist Cover	320/144	\$20,925
	KGL40	40 Gallon (150 Liter) Gas Kettle, 2" Tangent Draw-Off And Spring Assist Cover	520/235	\$23,490
	KGL40SH	40 Gallon (150 Liter) Gas Kettle, Short Series Full Steam Jacket,	520/235	\$24,284
	KGL60	60 Gallon (225 Liter) Gas Kettle, 2" Tangent Draw-Off And Spring Assist Cover	560/255	\$29,292
	KGL60SH	60 Gallon (225 Liter) Gas Kettle, Short Series Full Steam Jacket, 2" Tangent Draw-Off And Spring Assist Cover	560/255	\$31,792
	KGL80	80 Gallon (300 Liter) Gas Kettle, 2" Tangent Draw-Off And Spring Assist Cover	600/270	\$32,640
	KGL100	100 Gallon (375 Liter) Gas Kettle, 2" Tangent Draw-Off And Spring Assist Cover	620/280	\$39,535
GAS MODELS STATIONARY OPTIONS				
 <p>KGL40SH</p>	ELEVATION	Gas Models Specify Elevation If Over 2,000 Feet		\$0
	LPG	LP Gas Option		\$0
	KM2G	Gallon Markings - 5 Gallon Increments (Use KM2L for Liter increments)		\$758
	HS0001	Front Mounted Removable Heat Deflector Shield		\$910
	VOK4	220 Volt, 60Hz, 1 Phase (KGL Series Only)		\$586
	VOK5	220 -240 Volt, 50 Hz, 1 Phase (For Export KGL Series Only)		\$1,804
	CP-STATKT	Prison Package For Stationary Kettles, Tamper Proof Spring Assist Cover with HASP, Tangent Draw-Off Bar Style Protection, Switch Guard, Protect Box for Controls, Pressure Gauge Guard, Sight Glass Gauge Guard (See Page 50 for Details)		\$2,320
CP-RB	Prison Package Bar Rim		\$1,800	
TANGENT DRAW- OFF & PUMPABLE OPTIONS FOR STATIONARY GAS MODELS				
 <p>TD2</p>  <p>BV3AC</p>	2ACME	Acme Thread Added To 2" Tangent Draw-Off On Stationary Kettle (Special Order)		\$655
	TD3S	3" Tangent Draw-Off With Strainer Upgrade Add On Price		\$2,041
	TD3SA	3" Tangent Draw-Off With Acme Thread, For Pumping Capability		\$2,195
	BV3AC	3" Butterfly Valve With Acme Thread (Except KGL25T), For Pumping Capability		\$6,049
	FPVA3	3" Air Piston Valve For Pumping (KE003775-2) (Gas Models 60 Gallon And Larger) - For Pumping		\$7,894
COMMON ACCESSORIES				
 <p>DPK</p>	DPK5	Double Pantry Faucet		\$776
	SPK5	Single Pantry Faucet		\$600



PRSK



TBS-40



KAK

MODEL	DESCRIPTION	SHIP WT LBS/KGS	LIST PRICE
ACCESSORIES FOR STATIONARY MODELS CONTINUED			
SKFK	Single Pantry Kettle Filler (P/N 105978)		\$1,386
DKFK	Double Pantry Kettle Filler (P/N 105979)		\$1,667
PRSK	Pre-Rinse Spray Hose (P/N B-0113)		\$1,734
TBS-25	Tri-Basket System 25 Gal Model (Includes 3 BS-3's)		\$3,323
TBS-40	Tri-Basket System 40 Gal Model (Includes 3 BS-6's)		\$3,354
TBS-60	Tri-Basket System 60 Gal Model (Includes 3 BS-6's)		\$4,113
TBS-60	Tri-Basket System 60 Gal Model (Includes 3 BS-6's)		\$4,113
TBS-80	Tri-Basket System 80 Gal Model (Includes 3 BS-6's)		\$4,113
TBS-100	Tri-Basket System 100 Gal Model (Includes 3 BS-12's)		\$4,113
TBS-40SH	Tri-Basket System 40 Gal Model for SH Series (Includes 3 BS-6's)		\$4,113
TBS-60SH (GAS)	Tri-Basket System 60 Gal Models for SH Series (Includes 3 BS-6's)		\$4,113
KAK	Kettle Accessory Kit (P/N 40880) Includes items below from KBK to KL		\$1,572
KBK	Kettle Brush Kit (P/N 408802)		\$568
CB	Clean Up Brush (P/N 00856)		\$146
KP	Kettle Paddle (P/N 102405)		\$260
KW	Kettle Whip (P/N 00961)		\$521
KB	Kettle Brush (P/N 00853)		\$244
DB	Draw off Brush (P/N 00852)		\$146
KL	Kettle Ladle (P/N 00904)		\$420
SF4	Swing Drain Funnel for Stationary Kettles (P/N 1007841)		\$790
QDC60	5 Ft Long 3/4" Long Gas Quick Disconnect Hose (P/N 1007841)		\$902
TDDC	Drain Cup with Hose, for use with Tangent Draw-Off		\$692

KETTLES, GAS FLOOR MODEL — TILTING

SELF CONTAINED GAS KETTLES — TILTING

Cleveland Self Contained Tilting Floor Model Steam Jacketed Kettles, Gas Operated, Patented Forced Air "Double Pass" Self Contained Gas Steam Generator, 120 Volt With Cord & Plug, Solid State Temperature Control, 50 PSI Steam Jacket Rating, 316 Stainless Steel Kettle Interior, 2/3 Steam Jacketed, Built In Diagnostics, Reinforced Rolled Rim, 1 - 10 Steam Control Dial, Low Water LED Indicator, Color Coded Pressure Vacuum Gauge, Level Adjustable Flanged Feet, Certified to Applicable UL, CSA and NSF Standards, CE Certification

PRODUCT SERIES	MODEL	DESCRIPTION	SHIP WT LBS/KGS	LIST PRICE	
TILTING MODELS STANDARD - (2" TANGENT DRAW-OFF AND SPRING ASSIST COVER IS OPTIONAL)					
 KGL40T	KGL25T	25 Gallon (95 Liter) Gas Tilting With Standard Controls	320/144	\$32,204	
	KGL40T	40 Gallon (150 Liter) Gas Tilting With Standard Controls	520/235	\$35,461	
	KGL40TSH	40 Gallon (150 Liter) Gas Tilting - Short Series 38" Rim Height With Standard Controls, Full Steam Jacket	520/235	\$40,074	
	KGL60T	60 Gallon (225 Liter) Gas Tilting With Standard Controls	560/225	\$36,608	
	KGL80T	80 Gallon (300 Liter) Gas Tilting With Standard Controls	600/270	\$44,947	
EASYDIAL CONTROL OPTIONS TILTING GAS MODELS					
 KGL40TSH	EZD	EasyDial Control Option - Tilting Models Only		\$1,111	
	TCP1	Core Temperature Probe, EasyDial Controls Only (KE604132-1)		\$731	
GAS MODELS STATIONARY & TILTING ADDITIONAL OPTIONS					
 EZD	ELEVATION	Gas Models Specify Elevation If Over 2,000 Feet		\$0	
	LPG	LP Gas Option		\$0	
	KM2G	Gallon Markings - 5 Gallon Increments (Use KM2L for Liter Increments)		\$758	
	HS0001	Front Mounted Removable Heat Deflector Shield		\$910	
	VOK4	220 Volt, 60Hz, 1 Phase (KGL Series Only)		\$586	
	VOK5	220 -240 Volt, 50 Hz, 1 Phase (For Export KGL Series Only)		\$1,804	
	CP-TILTCTD	Prison Package For Tilting Kettles With TD Valve: Tamper Proof Spring Assist Cover with HASP, Tangent Draw-Off Bar Style Protection, Switch Guard, Protect Box for Controls, Pressure Gauge Guard, Sight Glass Gauge Guard, Hasp Lock by Others (See Page 50 for Details)		\$3,243	
	CP-TILTCT	Prison Package For Tilting Kettles With No TD Valve: Tamper Proof Spring Assist Cover with HASP, Switch Guard, Protect Box for Controls, Pressure Gauge Guard, Sight Glass Gauge Guard, HASP Lock by Others (See Page 50 for Details)		\$1,907	
	CP-RB	Prison Package Bar Rim		\$1,800	
	TANGENT DRAW-OFF (BUILT ON AT FACTORY)				
 TD2	TD2	2" Tangent Draw Off With Strainer		\$1,562	
	TD2A	2" Tangent Draw Off With Acme Thread And Strainer For Pumping Capability		\$1,810	
	TD3	3" Tangent Draw-Off With Strainer (60 Gallon And Larger Only)		\$4,801	
	TD3A	3" Tangent Draw-Off Valve With Acme Thread, (60 Gallon And Larger) For Pumping Capability		\$6,049	
	BV3AC	3" Butterfly Valve With Acme Thread (Except KGL25T) For Pumping Capability		\$6,049	
	FPVA3	3" Air Piston Valve For Pumping (KE003775-2) (Gas Models 60 Gallon And Larger) For Pumping		\$7,894	
 BV3A	SPRING ASSIST COVERS (BUILT ON AT FACTORY)				
	CHS25	25 Gallon Rotatable Spring Assist Cover With Built In Condensate Seal		\$1,560	
	CHS40	40 Gallon Rotatable Spring Assist Cover With Built In Condensate Seal		\$1,900	
	CHS40GTSH	40 Gallon Short Series Rotatable Spring Assist Cover With Built In Condensate Seal		\$2,187	
	CHS60	60 Gallon Rotatable Spring Assist Cover With Built In Condensate Seal		\$1,977	
	CHS80	80 Gallon Rotatable Spring Assist Cover With Built In Condensate Seal		\$2,229	
	CHS100	100 Gallon Rotatable Spring Assist Cover With Built In Condensate Seal		\$4,125	
 CHS25	ACCESSORIES				
	DPK25	Double Pantry Faucet and Bracket		\$776	
	SPK25	Single Pantry Faucet and Bracket		\$600	
	PCK	Self Leveling Pan Carrier (Tilting Models)		\$863	
	DPK26	Double Pantry Faucet and Bracket for KGL25T		\$776	
	SPK26	Single Pantry Faucet and Bracket for KGL25T		\$600	
	SKFK	Single Pantry Kettle Filler (P/N 105978)		\$1,386	
	DKFK	Double Pantry Kettle Filler (P/N 105979)		\$1,667	
	PRSK	Pre Rinse Spray Hose (P/N B-0113)		\$1,734	
	DRAINPAN6	6" Deep 12"x20" Stainless steel pan with drain		\$568	
	FD	Flow Diverter		\$1,801	



SPK25 DPK25

KETTLES, GAS FLOOR MODEL — TILTING



FS40

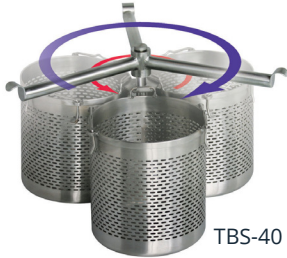

TBS-40



KAK

MODEL	DESCRIPTION	SHIP WT LBS/KGS	LIST PRICE
ACCESSORIES CONTINUED			
FS25	25 Gal food strainer		\$427
FS40SHG	40 Gal food strainer- SH Series Gas Models		\$1,223
FS60	60 Gal food strainer		\$1,223
FS80	80 Gal food strainer		\$3,053
TBS-25	Tri Basket System 25 Gal Models (includes 3 BS-3's)		\$3,323
TBS-40	Tri Basket System 40 Gal Models (includes 3 BS-6's)		\$3,354
TBS-60	Tri Basket System 60 Gal Models (includes 3 BS-6's)		\$4,113
TBS-80	Tri Basket System 80 Gal Models (includes 3 BS-6's)		\$4,113
TBS-40SH	Tri Basket System 40 Gal Models SH Series (includes 3 BS-6's)		\$4,113
SF3	Swing Drain Funnels for Tilting Kettles (KE003891-1, Floor Mounted)		\$790
KAK	Kettle Accessory Kit, includes all items below (P/N 40880)		\$1,572
KBK	Kettle Brush Kit (P/N 408802)		\$568
CB	Clean Up Brush (P/N 00856)		\$146
KP	Kettle Paddle (P/N 102405)		\$260
KW	Kettle Whip (P/N 00961)		\$521
KB	Kettle Brush (P/N 00853)		\$244
DB	Draw Off Brush (P/N 00852)		\$146
KL	Kettle Ladle (P/N 00904)		\$420

KETTLES, ELECTRIC FLOOR MODEL — STATIONARY

SELF CONTAINED ELECTRIC KETTLES — STATIONARY

Cleveland Self Contained Floor Model Stationary, Electric Standard 208 - 240 Volt, 3 Phase (Field Convertible To 1 Phase), 316 Stainless Steel Kettle Interior, Solid State Temperature Controls, IPX6 Water Rated, 50 PSI Steam Jacket Rating, 2/3 Steam Jacketed, Built In Diagnostics, Reinforced Rolled Rim, 1 - 10 Steam Control Dial, Low Water LED Indicator, Color Coded Pressure Vacuum Gauge, Level Adjustable Flanged Feet, Certified to Applicable UL, CSA and NSF Standards, CE Certification

PRODUCT SERIES	MODEL	DESCRIPTION	SHIP WT LBS/KGS	LIST PRICE	
STATIONARY MODELS STANDARD WITH 2" TANGENT DRAW-OFF AND SPRING ASSIST COVER					
 KEL40	KEL25	25 Gallon (95 Liter) Electric Kettle, 2" Tangent Draw-Off, Spring Assist Cover	210/95	\$18,569	
	KEL30	30 Gallon (110 Liter) Electric Kettle, 2" Tangent Draw-Off, Spring Assist Cover	230/105	\$18,739	
	KEL40	40 Gallon (150 Liter) Electric Kettle, 2" Tangent Draw-Off, Spring Assist Cover	280/127	\$19,127	
	KEL40SH	40 Gallon (150 Liter) Electric Kettle, Short Series, Full Steam Jacket, 2" Tangent Draw-Off, Spring Assist Cover	280/127	\$22,856	
	KEL60	60 Gallon (225 Liter) Electric Kettle, 2" Tangent Draw-Off, Spring Assist Cover	330/150	\$24,676	
	KEL60SH	60 Gallon (225 Liter) Electric Kettle, Short Series, Full Steam Jacket, 2" Tangent Draw-Off, Spring Assist Cover	340/155	\$30,039	
	KEL80	80 Gallon (300 Liter) Electric Kettle, 2" Tangent Draw-Off, Spring Assist Cover	385/175	\$31,613	
	KEL100	100 Gallon (375 Liter) Electric Kettle, 2" Tangent Draw-Off, Spring Assist Cover	415/195	\$36,306	
	OPTIONS (BUILT ON AT FACTORY)				
	 KEL40SH	ELEVATION	Specify Elevation If Over 3,000 Feet For Electric Models		\$0
HW2		High Wattage Option (Floor Model Electric Models KEL Series)		\$1,732	
VOK1		380 Or 415 Volt, 50 Hz, 3 Phase For KEL Electric Models - Export		\$709	
VOK2		440/480 Volt, 60 Hz, 3 Phase For KEL Electric Models		\$1,260	
KM2G		Gallon Markings - 5 Gallon Increments (Use KM2L for Liter Increments)		\$758	
HS001		Front Mounted Removable Heat Deflector Shield		\$910	
CP-STATKT		Prison Package For Stationary Kettles, Tamper Proof Spring Assist Cover with HASP, Tangent Draw-Off Bar Style Protection, Switch Guard, Protect Box for Controls, Pressure Gauge Guard, Sight Glass Gauge Guard (See Page 50 for Details)		\$2,320	
CP-RB		Prison Package Bar Rim		\$1,800	
TANGENT DRAW- OFF (BUILT ON AT FACTORY)					
 SPK5 DPK5		2ACME	Acme Thread Added To 2" Tangent Draw-Off On Stationary Kettle (Special Order)		\$655
	TD3S	3" Tangent Draw-Off With Strainer Upgrade/Add On Price (60 Gallon And Larger Only)		\$2,041	
	TD3SA	3" Tangent Draw-Off With Acme Thread Upgrade, Add On Price (60 Gallon And Larger Only)		\$2,195	
ACCESSORIES					
	DPK5	Double Pantry Faucet and Bracket Kit		\$776	
	SPK5	Single Pantry Faucet and Bracket Kit		\$600	
	SKFK	Single Pantry Kettle Filler (P/N 105978)		\$1,386	
	DKFK	Double Pantry Kettle Filler (P/N 105979)		\$1,667	
	PRSK	Pre Rinse Spray Hose (P/N B-0113)		\$1,734	
	TBS-25	Tri-Basket System 25 Gal Model (Includes 3 BS-3's)		\$3,323	
	TBS-40	Tri-Basket System 40 Gal Model (Includes 3 BS-6's)		\$3,354	
	TBS-60	Tri-Basket System 60 Gal Model (Includes 3 BS-6's)		\$4,113	
	TBS-60	Tri-Basket System 60 Gal Model (Includes 3 BS-6's)		\$4,113	
	TBS-80	Tri-Basket System 80 Gal Model (Includes 3 BS-6's)		\$4,113	
	TBS-100	Tri-Basket System 100 Gal Model (Includes 3 BS-12's)		\$4,113	
	TBS-40SH	Tri-Basket System 40 Gal Model for SH Series (Includes 3 BS-6's)		\$4,113	
	TBS-60SH	Tri-Basket System 60 Gal Models for SH Series (Includes 3 BS-6's)		\$4,114	
	KAK	Kettle Accessory Kit (P/N 40880) Includes items below from KBK to KL		\$1,572	
	KBK	Kettle Brush Kit (P/N 408802)		\$568	
	CB	Clean Up Brush (P/N 00856)		\$146	
	KP	Kettle Paddle (P/N 102405)		\$260	
	KW	Kettle Whip (P/N 00961)		\$521	
	KB	Kettle Brush (P/N 00853)		\$244	
	DB	Draw off Brush (P/N 00852)		\$146	
	KL	Kettle Laddle (P/N 00904)		\$420	
	SF4	Swing Drain Funnel for Stationary Kettles (P/N 1007841)		\$790	
	TDDC	Drain Cup with Hose, for use with Tangent Draw-Off		\$692	

KETTLES, ELECTRIC FLOOR — TILTING

SELF CONTAINED ELECTRIC KETTLES — TILTING

Cleveland Self Contained Floor Model Tilting Kettles, Electric Standard 208 - 240 Volt, 3 Phase (Field Convertible To 1 Phase), 316 Stainless Steel Kettle Interior, 50 PSI Steam Jacket Rating, 2/3 Steam Jacketed, Solid State Temperature Controls, IPX6 Water Rated, Built In Diagnostics, Reinforced Rolled Rim, 1 - 10 Steam Control Dial, Low Water LED Indicator, Color Coded Pressure Vacuum Gauge, Level Adjustable Flanged Feet, Certified to Applicable UL, CSA and NSF Standards, CE Certification

PRODUCT SERIES	MODEL	DESCRIPTION	SHIP WT LBS/KGS	LIST PRICE
TILTING MODELS (2" TANGENT DRAW-OFF AND SPRING ASSIST COVER IS OPTIONAL)				
 <p>KEL25T</p>	KEL25T	25 (95 Liter) Gallon Electric Tilting With Standard Controls	290/132	\$24,919
	KEL40T	40 (150 Liter) Gallon Electric Tilting With Standard Controls	360/163	\$26,643
	KEL40TSH	40 Gallon (150 Liter) Electric Tilting - Short Series 35" Rim Height With Standard Controls, Full Steam Jacket, No TD3	360/163	\$27,627
	KEL60T	60 Gallon (225 Liter) Electric Tilting With Standard Controls	415/188	\$30,473
	KEL60TSH	60 Gallon (225 Liter) Electric Tilting - Short Series 35" Rim Height With Standard Controls, Full Steam Jacket.	415/188	\$39,125
	KEL80T	80 Gallon (300 Liter) Electric Tilting With Standard Controls	470/213	\$35,163
 <p>KEL100T</p>	KEL100T	100 Gallon (375 Liter) Electric Tilting With Standard Controls	520/235	\$41,870
	EASYDIAL CONTROL OPTIONS TILTING MODELS ONLY			
 <p>EZYD</p>	EZD	EasyDial Control Option - Tilting Models Only		\$1,111
	TCP1	Core Temperature Probe, EasyDial Controls Only (KE604132-1)		\$731
ELECTRIC TILTING MODELS ADDITIONAL OPTIONS				
 <p>EZD</p>	ELEVATION	Specify Elevation If Over 3,000 Feet		\$0
	HW2	High Wattage Option (Floor Model Electric Models KEL Series)		\$1,732
	VOK1	380 Or 415 Volt, 50 Hz, 3 Phase For KEL Electric Models - Export		\$709
	VOK2	440/480 Volt, 60 Hz, 3 Phase For KEL Electric Models		\$1,260
	KM2G	Gallon Markings - 5 Gallon Increments (Use KM2L for Liter Increments)		\$758
	HS001	Front Mounted Removable Heat Deflector Shield		\$910
	CP-TILTCTD	Prison Package For Tilting Kettles With TD Valve: Tamper Proof Spring Assist Cover with HASP, Tangent Draw-Off Bar Style Protection, Switch Guard, Protect Box for Controls, Pressure Gauge Guard, Sight Glass Gauge Guard, Hasp Lock by Others		\$3,243
	CP-TILTCT	Prison Package For Tilting Kettles With No TD Valve: Tamper Proof Spring Assist Cover with HASP, Switch Guard, Protect Box for Controls, Pressure Gauge Guard, Sight Glass Gauge Guard, HASP Lock by Others		\$1,907
	CP-RB	Prison Package Bar Rim		\$1,800
	TANGENT DRAW-OFF (BUILT ON AT FACTORY)			
 <p>TD2</p>	TD2	2" Tangent Draw Off With Strainer, Not Available In Short Series		\$1,560
	TD3	3" Tangent Draw-Off With Strainer (60 Gallon And Larger Only)		\$4,801
	TD2A	2" Tangent Draw Off With Acme Thread And Strainer For Pumping (Special Order)		\$1,810
	TD3A	3" Tangent Draw-Off Valve With Acme Thread, (60 Gallon And Larger) For Pumping		\$6,049
SPRING ASSIST COVERS, TILTING MODELS				
 <p>CHS25</p>	CHS25	25 Gallon Rotatable Spring Assist Cover With Built In Condensate Seal		\$1,560
	CHS40	40 Gallon Rotatable Spring Assist Cover With Built In Condensate Seal		\$1,900
	CHS40ETSH	40 SH Series Gallon Rotatable Spring Assist Cover With Built In Condensate Seal		\$2,044
	CHS60	60 Gallon Rotatable Spring Assist Cover With Built In Condensate Seal		\$1,977
	CHS60ETSH	60 SH Series Gallon Rotatable Spring Assist Cover With Built In Condensate Seal		\$2,052
	CHS80	80 Gallon Rotatable Spring Assist Cover With Built In Condensate Seal		\$2,229
	CHS100	100 Gallon Rotatable Spring Assist Cover With Built In Condensate Seal		\$4,215
ACCESSORIES				
 <p>SPK28</p>  <p>DPK28</p>	DPK28	DPKT Double Pantry Faucet & Bracket, Large 3/4" Spout		\$776
	SPK28	SPKT Single Pantry Faucet & Bracket Large 3/4" Spout		\$600
	DPK30	Double Pantry Faucet and Bracket, Large 3/4" Spout KEL25T		\$776
	SPK30	Single Pantry Faucet and Bracket, Large 3/4" Spout KET25T		\$600
	DPK33	Double Pantry Faucet and Bracket, Large 3/4" Spout KEL40/60TSH		\$776
	SPK33	Single Pantry Faucet and Bracket, Large 3/4" Spout KET40/60TSH		\$600
	SKFK	Single Pantry Kettle Filler		\$1,386
	DKFK	Double Pantry Kettle Filler		\$1,667
PRSK	Pre Rinse Spray Hose (P/N B-0113)		\$1,734	

KETTLES, ELECTRIC FLOOR — TILTING

MODEL	DESCRIPTION	SHIP WT LBS/KGS	LIST PRICE
ACCESSORIES			
PCK	Self Leveling Pan Carrier (tilting models)		\$863
DRAINPAN6	6" Deep, 12"x20" Stainless Steel Pan with Drain		\$568
FD	Flow Diverter		\$1,801
FS25	25 Gal food strainer		\$427
FS40	40 Gal food strainer		\$1,223
FS40SHG	40 Gal food strainer- SH Series Gas Models		\$1,516
FS60	60 Gal food strainer		\$1,223
FS80	80 Gal food strainer		\$3,053
TBS-25	Tri Basket System 25 Gal Models (includes 3 BS-3's)		\$3,323
TBS-40	Tri Basket System 40 Gal Models (includes 3 BS-6's)		\$3,354
TBS-60	Tri Basket System 60 Gal Models (includes 3 BS-6's)		\$4,113
TBS-80	Tri Basket System 80 Gal Models (includes 3 BS-6's)		\$4,113
TBS-40SH	Tri Basket System 40 Gal Models SH Series (includes 3 BS-6's)		\$4,113
SF3	Swing Drain Funnels for Tilting Kettles (KE003891-1, Floor Mounted)		\$790
KAK	Kettle Accessory Kit, includes all items below (P/N 40880)		\$1,572
KBK	Kettle Brush Kit (P/N 408802)		\$568
CB	Clean Up Brush (P/N 00856)		\$146
KP	Kettle Paddle (P/N 102405)		\$260
KW	Kettle Whip (P/N 00961)		\$521
KB	Kettle Brush (P/N 00853)		\$244
DB	Draw Off Brush (P/N 00852)		\$146
KL	Kettle Ladle (P/N 00904)		\$420



FS40



FD



KAK

KETTLES, COUNTER TOP DIRECT STEAM & KETTLE COMBINATIONS ON 18" STANDS

COUNTER TOP KETTLES, DIRECT STEAM

Cleveland Self Direct Steam Counter Top Kettles, 50 PSI Steam Jacket Rating, 316 Stainless Steel Interior, 2/3 Steam Jacketed, 316 Stainless Steel Kettle Interior, Reinforced Rolled Rim, Right Hand Steam Control Valve, Certified to Applicable UL, CSA and NSF Standards, CE Certification

PRODUCT SERIES	MODEL	DESCRIPTION	SHIP WT LBS/KGS	LIST PRICE
	KDT1T	.5 Gallon (2 Liter) Direct Steam Tilting, 2/3 Steam Jacketed	20/9	\$6,811
	KDT3T	3 Gallon (11L) Direct Steam Tilting 2/3 Rd Steam Jacketed.	38/17	\$6,274
	KDT6T	6 Gallon (23 Liter) Direct Steam Tilting, 2/3 Steam Jacketed	40/18	\$6,046
	KDT10T	10 Gallon (38 Liter) Direct Steam Tilting, 2/3 Steam Jacketed	55/25	\$7,546
	KDT12T	12 Gallon (45 Liter) Direct Steam Tilting, 2/3 Steam Jacketed	55/25	\$9,647
	KDT20T	20 Gallon (80 Liter) Direct Steam Tilting, 2/3 Steam Jacketed	90/41	\$12,938
	ST28KDT12T	KDT12T, 12 Gallon Direct Steam Kettle mounted on ST28 Stand with using AK12-ST28 Adapter Kit		\$12,677

KDT12T

COMMON ACCESSORIES (FOR MORE ACCESSORIES SEE ALL KETTLE ACCESSORIES PAGE)

SCK2	SCK2 - Steam Controls Kit (Steam Trap, Strainer, Check Valve)	\$1,138
CL1 (3,6)	Lift Off Cover With Built In Condensate Seal	\$512
CL12	Lift Off Cover With Built In Condensate Seal	\$664
CL20	Lift Off Cover With Built In Condensate Seal	\$702

ADAPTER TOPS FOR KDT SERIES, USED ON ST SERIES STANDS

AK-12-ST28	Adapter Top For ST Stands, 12 Gallon Models, For Mounting To ST28 Stand	\$1,296
AK-20-ST28	Adapter Top For ST Stands, 20 Gallon Models, For Mounting To ST28 Stand	\$1,296
AK-3/3-ST42	Adapter Top For ST Stands, 3 Gallon Models, For Mounting To ST42 Stand	\$1,296
AK-3/6-ST42	Adapter Top For ST Stands, 6 Gallon Models For Mounting To ST42 Stand	\$1,296
AK-3-ST28	Adapter Top For ST Stands, 3 Gallon Models For Mounting To ST28 Stand	\$1,296
AK-6/12-ST42	Adapter Top For ST Stands, 6 and 12 Gallon Models For Mounting To ST42 Stand	\$1,296
AK-6/6-ST42	Adapter Top For ST Stands, (2) 6 Gallon Models For Mounting To ST42 Stand	\$1,296
AK-6-ST28	Adapter Top For ST Stands, 6 Gallon Models For Mounting To ST28 Stand	\$1,296
AK12-ST55	Adapter Top For ST Stands, (2) 12 Gallons Models For Mounting To ST55 Stand	\$1,296

ST SERIES EQUIPMENT STANDS

Heavy Stainless Steel Construction With 1-1/4' Square Tubing, Adjustable Feet, (Rear Flanged Feet For Bolting To Floor) Standard With Sliding Drain Drawer And Splash Screen, Can Be Hard Piped To Floor Drain, Certified to Applicable UL, CSA and NSF Standards

PRODUCT SERIES	MODEL	DESCRIPTION	SHIP WT LBS/KGS	LIST PRICE
	EST28G	28" Economy Equipment Stand, No Drain Drawer For Single Kettle	28/13	\$1,569
	ST-28G	28" Wide Equipment Stand W/ Drain Drawer And Splash Screen For Single Kettle	35/16	\$2,376
	ST-42G	42" Wide Equipment Stand W/ Drain Drawer And Splash Screen (For Two KDT6T'S - Must order Adapter Top)	65/29	\$4,510
	ST55G	55" Wide Equipment Stand W/ Drain Drawer And Splash Screen (For (2) KDT6T, KDT12T - Must order Adapter Top)	70/32	\$4,854
	SG28G	Large Flow Folding Splash Guard For ST28, ST55		\$280
	SG42G	Large Flow Folding Splash Guard For ST42 Equipment Stand		\$275

DIRECT STEAM KETTLES — 18" HIGH MODULAR STAND

Cleveland Direct Steam Modular Bases, 18" High Base With Full Width Drain Trough And Grate with Sliding Drain Pan (SDP1), 316 Stainless Steel Interior, Double Pantry Faucet, Splash Guard, Level Adjustable Flanged Feet, 316 Stainless Steel Standard, Certified to Applicable UL, CSA and NSF Standards





PRODUCT SERIES	MODEL	DESCRIPTION	SHIP WT LBS/KGS	LIST PRICE
	SD450K6	One 6-Gallon Kettle On 18" Wide Modular Base	40/64	\$15,332
	SD650K12	One 12-Gallon Kettle On 18" Wide Modular Base	160/73	\$17,603
	SD760K12	One 6-Gallon Kettle On 26" Wide Modular Base	175/79	\$18,372
	SD1050K66	Two 6-Gallon Kettles On 42" Wide Modular Base	210/95	\$23,294
	SD1200K612	One 6, One 12 Gallon Kettle On 48" Wide Modular Base	230/104	\$26,302
	SD1600K1212	One 6, One 20 Gallon Kettle On 63" Wide Modular Base	290/132	\$32,848
	SD1600K620	Two 12 Gallon Kettle On 63" Wide Modular Base	250/114	\$32,848
	SD1800K2020	Two 20 Gallon Kettles On 71" Wide Modular Base	340/154	\$39,913

SD1050K66

KETTLES, DIRECT STEAM FLOOR MODEL — STATIONARY

DIRECT STEAM STATIONARY KETTLES









Cleveland Direct Steam Floor Model Stationary Kettles, 50 PSI Steam Jacket Rating, 316 Stainless Steel Kettle Interior, 2/3 Steam Jacketed, 2" Tangent Draw Off Valve, Rotatable Spring Assist Cover, Reinforced Rolled Rim, Steam Control Valve, Level Adjustable Flanged Feet, Certified to Applicable UL, CSA and NSF Standards, CE Certification

PRODUCT SERIES	MODEL	DESCRIPTION	SHIP WT LBS/KGS	LIST PRICE	
TILTING MODELS (2" TANGENT DRAW-OFF AND SPRING ASSIST COVER IS OPTIONAL)					
 KDL40	KDL25	25 Gallon (95 Liter) Direct Steam Tri-Leg, 2/3 Steam Jacketed	170/77	\$11,829	
	KDL30F	30 Gallon (110 Liter) Direct Steam Tri-Leg, Full Steam Jacketed	135/61	\$20,565	
	KDL40	40 Gallon (150 Liter) Direct Steam Tri-Leg, 2/3 Steam Jacketed	230/104	\$12,139	
	KDL40SH	40 Gallon (150 Liter) Direct Steam Tri-Leg, Full Steam Jacketed Short Series, Full Steam Jacket	230/104	\$16,991	
	KDL60	60 Gallon (225 Liter) Direct Steam Tri-Leg, 2/3 Steam Jacketed	260/150	\$14,591	
	KDL60SH	60 Gallon (225 Liter) Direct Steam Tri-Leg, Full Steam Jacketed Short Series Full Steam Jacket	260/150	\$20,403	
	KDL80	80 Gallon (300 Liter) Direct Steam Tri-Leg, 2/3 Steam Jacketed	290/130	\$17,370	
	KDL80SH	80 Gal. (300 Liter) Direct Steam Tri-Leg, Full Steam Jacketed Short Series Full Steam Jacket	290/180	\$23,247	
	KDL100	100 Gallon (375 Liter) Direct Steam Tri-Leg, 2/3 Steam Jacketed	350/150	\$23,461	
	KDL100F	100 Gallon (375 Liter) Direct Steam Tri-Leg, Full Steam Jacketed	360/163	\$44,897	
 KDL40SH	KDL125	125 Gallon (475 Liter) Direct Steam Tri-Leg, 2/3 Steam Jacketed	410/170	\$29,864	
	KDL125F	125 Gallon (475 Liter) Direct Steam Tri-Leg, Full Steam Jacketed	410/185	\$53,988	
	KDL150	150 Gallon (575 Liter) Direct Steam Tri-Leg, 2/3 Steam Jacketed	490/196	\$33,150	
	KDL200	200 Gallon (757 Liter) Direct Steam Tri-Leg, 2/3 Steam Jacketed	560/255	\$45,749	
	KDP40	40 Gallon (150 L) Direct Steam, Pedestal Base, 2/3 Steam Jacketed	230/104	\$15,149	
	KDP60	60 Gallon (225 L) Direct Steam, Pedestal Base, 2/3 Steam Jacketed	260/150	\$18,076	
	KDP80	80 Gallon (300 L) Direct Steam, Pedestal Base, 2/3 Steam Jacketed	290/130	\$21,388	
	KDP100	100 Gal (375 L) Direct Steam, Pedestal Base, 2/3 Steam Jacketed	360/150	\$26,329	
	OPTIONS				
	BV3A	3" Butterfly Valve With Acme Thread (Except KGL25T), 90 Degree Elbow, 8' Long Food Grade Hose			\$2,426
KM2G	Gallon Markings - 5 Gallon Increments (Use KM2L for Liter Increments)			\$758	
HS001	Front Mounted Removable Heat Deflector Shield			\$910	
CP-STATKT	Prison Package For Stationary Kettles, Tamper Proof Spring Assist Cover with HASP, Tangent Draw-Off Bar Style Protection, Switch Guard, Protect Box for Controls, Pressure Gauge Guard, Sight Glass Gauge Guard (See Page 50 for Details)			\$2,320	
CP-RB	Prison Package Bar Rim			\$1,800	
COMMON ACCESSORIES (FOR MORE ACCESSORIES SEE ALL KETTLE ACCESSORIES PAGE 22-24)					
DPK5	DPKT Double Pantry Faucet, Large 3/4" Spout			\$776	
SPK5	SPKT Single Pantry Faucet, Large 3/4" Spout			\$600	
SCK2	Steam Controls Kit (Steam Trap, Strainer, Check Valve)			\$1,138	
 SPK5	TBS-25	Tri-Basket System 25 Gal Model (Includes 3 BS-3's)		\$3,323	
	TBS-40	Tri-Basket System 40 Gal Model (Includes 3 BS-6's)		\$3,354	
 DPK5	TBS-60	Tri-Basket System 60 Gal Model (Includes 3 BS-6's)		\$4,113	
	TBS-80	Tri-Basket System 80 Gal Model (Includes 3 BS-6's)		\$4,113	
	TBS-100	Tri-Basket System 100 Gal Model (Includes 3 BS-12's)		\$4,113	
	TBS-40SH	Tri-Basket System 40 Gal Model for SH Series (Includes 3 BS-6's)		\$4,113	
	TBS-60SH	Tri-Basket System 60 Gal Models for SH Series (Includes 3 BS-6's)		\$4,113	
	KAK	Kettle Accessory Kit (P/N 40880) Includes items below from KBK to KL		\$1,572	
	KBK	Kettle Brush Kit (P/N 408802)		\$568	
	CB	Clean Up Brush (P/N 00856)		\$146	
	KP	Kettle Paddle (P/N 102405)		\$260	
	KW	Kettle Whip (P/N 00961)		\$521	
	KB	Kettle Brush (P/N 00853)		\$244	
	DB	Draw off Brush (P/N 00852)		\$146	
	KL	Kettle Laddle (P/N 00904)		\$420	
	SF4	Swing Drain Funnel for Stationary Kettles (P/N 1007841)		\$790	
	TDDC	Drain Cup with Hose, for use with Tangent Draw-Off		\$692	

KETTLES, FLOOR MODEL, DIRECT STEAM — TILTING

DIRECT STEAM KETTLES — TILTING

Cleveland Direct Steam Floor Model Tilting Kettles, 50 PSI Steam Jacket Rating, 2/3 Steam Jacketed, 316 Stainless Steel Kettle Interior, Reinforced Rolled Rim, Steam Control Valve, Level Adjustable Flanged Feet, Certified to Applicable UL, CSA and NSF Standards, CE Certification

PRODUCT SERIES	MODEL	DESCRIPTION	SHIP WT LBS/KGS	LIST PRICE
 KDL40T	KDL25T	25 Gallon (95 Liter) Direct Steam Tilting, Steam Jacketed Tri-Leg Design	220/110	\$13,438
	KDL40T	40 Gallon (150 Liter) Direct Steam Tilting, Steam Jacketed Tri-Leg Design	275/125	\$14,144
	KDL40TSH	40 Gal. (150 Liter) Direct Steam Tilting, Full Steam Jacketed -Tri Leg Short Series 35"	230/104	\$20,173
	KDL60T	60 Gallon (225 Liter) Direct Steam Tilting, 2/3 Steam Jacketed Tri-Leg Design	345/157	\$16,716
	KDL60TSH	60 Gal.(225 Liter) Direct Steam Tilting, Full Steam Jacketed -Short Series 35" Rim	260/150	\$23,953
	KDL80T	80 Gal. (300 Liter) Direct Steam Tilting, 2/3 Steam Jacketed Quad Leg Design	415/188	\$18,971
	KDL80TSH	80 Gal. (300 Liter) Direct Steam Tilting, Full Steam Jacketed -Short Series 35" Rim	290/255	\$27,485
	KDL100T	100 Gallon (375 Liter) Direct Steam Tilting, 2/3 Steam Jacketed Quad Leg Design	475/216	\$23,915
	KDL125T	125 Gal. (475 Liter) Direct Steam Tilting, 2/3 Steam Jacketed Quad Leg Design	535/244	\$28,828
	KDL150T	150 Gal. (575 Liter) Direct Steam Tilting, 2/3 Steam Jacketed Quad Leg Design	595/270	\$34,035
TANGENT DRAW-OFF OPTIONS (BUILT ON AT FACTORY)				
 KDL40TSH	TD2	2" Tangent Draw Off Drain With Strainer		\$1,562
	TD3	3" Tangent Draw-Off With Strainer (60 Gallon And Larger Only, Not Available On KDM'S)		\$4,801
	BV3AC	3" Butterfly Valve With Acme Thread, 90 Degree Elbow, 8' Long Food Grade Hose (Special Order)		\$6,049
SPRING ASSIST COVER OPTIONS TILTING MODELS				
 TD2	CHS25	25 Gallon Spring Assist Rotatable Cover With Built In Condensate Seal Standard		\$1,560
	CHS40	40 Gallon Spring Assist Rotatable Cover With Built In Condensate Seal Standard		\$1,900
	CHS40DTSH	40 Gallon Short Series Spring Assist Rotatable Cover With Built In Condensate Seal Standard		\$2,044
	CHS60	60 Gallon Spring Assist Rotatable Cover With Built In Condensate Seal Standard		\$1,977
	CHS60DTSH	60 Gallon Short Series Spring Assist Rotatable Cover With Built In Condensate Seal Standard		\$2,052
	CHS80	80 Gallon Spring Assist Rotatable Cover With Built In Condensate Seal Standard		\$2,229
	CHS80DTSH	80 Gallon Short Series Spring Assist Rotatable Cover With Built In Condensate Seal Standard		\$2,229
 BV3A	CHS100	100, 125, 150 Gal. Spring Assist Rotatable Cover With Built In Condensate Seal Standard		\$3,940
	OPTIONS (BUILT ON AT FACTORY)			
 CHS25	KM2G	KM2G Gallon Markings (Use KM2L for Liter Increments)		\$758
	HS001	Front Mounted Removable Heat Deflector Shield		\$910
	CP-TILTCTD	Prison Package For Tilting Kettles With TD Valve: Tamper Proof Spring Assist Cover with HASP, Tangent Draw-Off Bar Style Protection, Switch Guard, Protect Box for Controls, Pressure Gauge Guard, Sight Glass Gauge Guard, Hasp Lock by Others (See Page 50 for Details)		\$3,243
	CP-TILTCT	Prison Package For Tilting Kettles With No TD Valve: Tamper Proof Spring Assist Cover with HASP, Switch Guard, Protect Box for Controls, Pressure Gauge Guard, Sight Glass Gauge Guard, HASP Lock by Others (See Page 50 for Details)		\$1,907
	CP-RB	Heavy Duty Bar Rim		\$1,800
	ACCESSORIES			
 PCK	DPK31	Double Pantry Faucet & Bracket, Large 3/4" Spout (60,80,100 Gallon Models)		\$776
	SPK31	Single Pantry Faucet & Bracket Large 3/4" Spout (60,80,100 Gallon Models)		\$600
	SPK32	Single Pantry Faucet & Bracket Large 3/4" Spout (25, 40 Gallon Models)		\$600
	DPK32	Double Pantry Faucet & Bracket, Large 3/4" Spout (25, 40 Gallon Models)		\$776
	DPK31	Double Pantry Faucet & Bracket, Large 3/4" Spout (KDL60/80/100T)		\$1776
	SPK31	Single Pantry Faucet & Bracket Large 3/4" Spout (KDL60/80/100T)		\$600
	DPK33	Double Pantry Faucet & Bracket, Large 3/4" Spout (KDL 40/60/80T)		\$776
	SPK33	Single Pantry Faucet & Bracket Large 3/4" Spout (KDL 40/60/80T)		\$600
	SKFK	Single Pantry Kettle Filler (P/N 105978)		\$1,386
	DKFK	Double Pantry Kettle Filler (P/N 105979)		\$1,667
 SPKS	PRSK	Pre Rinse Spray Hose (P/N B-0113)		\$1,734
 DPKS				

KETTLES, FLOOR MODEL, DIRECT STEAM — TILTING



FS40







FD



KAK

MODEL	DESCRIPTION	SHIP WT LBS/KGS	LIST PRICE
ACCESSORIES CONTINUED			
PCK	Self Leveling Pan Carrier (tilting models)		\$863
DRAINPAN6	6" Deep, 12"x20" Stainless Steel Pan with Drain		\$568
FD	Flow Diverter		\$1,801
FS40	40 Gal food strainer		\$1,223
FS40SHG	40 Gal food strainer- SH Series Gas Models		\$1,516
FS60	60 Gal food strainer		\$1,223
FS80	80 Gal food strainer		\$3,053
TBS-25	Tri Basket System 25 Gal Models (includes 3 BS-3's)		\$3,323
TBS-40	Tri Basket System 40 Gal Models (includes 3 BS-6's)		\$3,354
TBS-60	Tri Basket System 60 Gal Models (includes 3 BS-6's)		\$4,113
TBS-80	Tri Basket System 80 Gal Models (includes 3 BS-6's)		\$4,113
TBS-40SH	Tri Basket System 40 Gal Models SH Series (includes 3 BS-6's)		\$4,113
SF3	Swing Drain Funnels for Tilting Kettles (KE003891-1, Floor Mounted)		\$790
KAK	Kettle Accessory Kit, includes all items below (P/N 40880)		\$1,572
KBK	Kettle Brush Kit (P/N 408802)		\$568
CB	Clean Up Brush (P/N 00856)		\$146
KP	Kettle Paddle (P/N 102405)		\$260
KW	Kettle Whip (P/N 00961)		\$521
KB	Kettle Brush (P/N 00853)		\$244
DB	Draw Off Brush (P/N 00852)		\$146
KL	Kettle Ladle (P/N 00904)		\$420

ALL KETTLE ACCESSORIES

PRODUCT SERIES	MODEL	DESCRIPTION	SHIP WT LBS/KGS	LIST PRICE
LIFT OFF COVERS — LID HOLDERS				
 <p>CL-20</p>  <p>LCH-20</p>	CL-1	1 Gallon Lift Off Cover		\$512
	CL-3	3 Gallon Lift Off Cover with Built In Condensate Seal		\$512
	CL-6	6 Gallon Lift Off Cover with Built In Condensate Seal		\$512
	CL-10	10 Gallon Lift Off Cover with Built In Condensate Seal		\$532
	CL-12	12 Gallon Lift Off Cover with Built In Condensate Seal		\$664
	CL-20	20 Gallon Lift Off Cover with Built In Condensate Seal		\$702
	CL-25	25 Gallon Lift Off Cover with Built In Condensate Seal		\$1,029
	CL-40	40 Gallon Lift Off Cover with Built In Condensate Seal		\$1,217
	CL-60	60 Gallon Lift Off Cover with Built In Condensate Seal		\$1,350
	CL-80	80 Gallon Lift Off Cover with Built In Condensate Seal		\$1,547
	CL-100	100 Gallon Lift Off Cover with Built In Condensate Seal		\$1,745
	LCH-3	3 Gallon Lid Holder For KET3T (KE003927-3)		\$249
	LCH-6	6 Gallon Lid Holder Lid Holder KET6T (KE003927-2)		\$249
	LCH-12	12 Gallon Lid Holder KET12T (KE003927-1)		\$249
	LCH-20	20 Gallon Lid Holder KET20T (KE003927-4)		\$249
	LCH-6G	6 Gallon Lid Holder Lid Holder KGT6T (KE003980-2)		\$249
	LCH-12G	12 Gallon Lid Holder Lid Holder KGT12T (KE003980-1)		\$249
FAUCETS				
 <p>SPK</p>  <p>DPK</p>  <p>DKFK</p>	SPK1	Single Pantry Faucet (KDT12T, KDT20T SD Or ST Stand Mounted)		\$600
	DPK1	Double Pantry Faucet (KDT12T, KDT20T SD Or ST Stand Mounted)		\$776
	SPK2	Single Pantry Faucet And Bracket Kit (KDL/P60T, KDL/P80T, KDL/P100T, MKET12/20T)		\$600
	DPK2	Double Pantry Faucet And Bracket Kit (KDL/P60T, KDL/P80T, KDL/P100T, MKET12/20T)		\$776
	SPK5	Single Pantry Faucet (All Stationary Kettles Except HA-MKGL)		\$600
	DPK5	Double Pantry Faucet And Bracket Kit (All Stationary Kettles Except HA-MKGL)		\$776
	SPK6	Single Pantry Faucet (KDM25, KDM40T)		\$600
	DPK6	Double Pantry Faucet (KDM25, KDM40T)		\$776
	SPK8	Single Pantry Faucet And Bracket Kit (KDT6T SD Or ST Stand Mounted)		\$600
	DPK8	Double Pantry Faucet And Bracket Kit (KDT6T SD or ST Stand Mounted)		\$776
	SPK10	Single Pantry Faucet And Bracket Kit (KDL100T, KDL125T)		\$600
	DPK10	Double Pantry Faucet And Bracket Kit (KDL100T, KDL125T)		\$776
	SPK11	Single Pantry Faucet And Bracket Kit (HAMKGL60T, 80T, 100-T)		\$629
	DPK11	Double Pantry Faucet And Bracket Kit (HAMKGL60T, 80T, 100-T)		\$776
	SPK17	Single Pantry Faucet And Bracket Kit (HAMKGL60, 80, 100)		\$629
	DPK17	Double Pantry Faucet And Bracket Kit (HAMKGL60, 80, 100)		\$776
	SPK18	Single Pantry Faucet And Bracket Kit (KDM60T)		\$629
DPK18	Double Pantry Faucet And Bracket Kit (KDM60T)		\$776	
SPK25	Single Pantry Faucet And Bracket Kit (KGL40/60/80T, KGL40TSH)		\$600	
DPK25	Double Pantry Faucet And Bracket Kit (KGL40/60/80T, KGL40TSH)		\$776	
SPK26	Single Pantry Faucet And Bracket Kit (KGL25T)		\$600	
DPK26	Double Pantry Faucet And Bracket Kit (KGL25T)		\$776	
SPK27	Single Pantry Faucet And Bracket Kit (KET3T, 6T, 12T, TKET3T, 6T, 12T)		\$600	
DPK27	Double Pantry Faucet And Bracket Kit (KET3, 6, 12T, TKET3T, 6T, 12T)		\$776	
SPK28	Single Pantry Faucet And Bracket Kit (KEL40/60/80/100T, KET20T)		\$600	
DPK28	Double Pantry Faucet And Bracket Kit (KEL40/60/80/100T, KET20T)		\$776	
SPK30	Single Pantry Faucet And Bracket Kit (KEL25T)		\$600	
DPK30	Double Pantry Faucet And Bracket Kit (KEL25T)		\$776	
SPK31	Single Pantry Faucet And Bracket Kit (KDL60/80/100T)		\$600	
DPK31	Double Pantry Faucet And Bracket Kit (KDL60/80/100T)		\$776	
SPK32	Single Pantry Faucet And Bracket Kit (KDL25/40T)		\$600	
DPK32	Double Pantry Faucet And Bracket Kit (KDL25/40T)		\$776	
SPK33	Single Pantry Faucet And Bracket Kit (KDL40/60/80TSH, KEL40/60TSH)		\$600	
DPK33	Double Pantry Faucet And Bracket Kit (KDL40/60/80TSH, KEL40/60TSH)		\$776	
SKFK	Single Pantry Kettle Filler (P/N 105978)		\$1,386	
DKFK	Double Pantry Kettle Filler (P/N 105979)		\$1,667	
PRSK	Pre-Rinse Spray Hose (P/N B-0113)		\$1,734	
FBKT	Faucet Bracket Kettles		\$250	

ALL KETTLE ACCESSORIES (CONTINUED)

PRODUCT SERIES	MODEL	DESCRIPTION	SHIP WT LBS/KGS	LIST PRICE
PAN CARRIER, FOOD & DRAIN STRAINERS, COOKING BASKETS				
	PCK	Pan Carrier Kettles For Tilting Kettles		\$863
	FD	Flow Diverter		\$1,801
	DRAINPAN6	6" Deep 12" X 20" Stainless Steel Pan With Drain		\$563
	SDP1	Sliding Drain Pan for SD Stands		\$571
	DS-2	Perforated Drain Strainer, 2" Draw-Off, 3/16" Strainer Holes		\$422
	DS-2S	Solid Drain Strainer, 2" Draw-Off, 3/16" Strainer Holes		\$422
	DS-3	Perforated Drain Strainer, 3" Draw-Off, 3/16" Strainer Holes		\$422
	DS-3S	Solid Drain Strainer, 3" Draw-Off, 3/16" Strainer Holes		\$422
	MKDS-2/316A	Drain Strainer For Vertical Mixer Kettles 2" Draw-Off		\$388
	MKDS-3/316A	Drain Strainer For Vertical Mixer Kettles 3" Draw-Off		\$388
	SH-25	Drain Strainer Hook, 25 gallon (100 Liter) Kettle (PN KE51462)		\$365
	SH-40	Drain Strainer Hook, 40 gallon (150 Liter) Kettle (PN KE51464)		\$365
	SH-60	Drain Strainer Hook, 60 gallon (225 Liter) Kettle (PN KE51465)		\$365
	SH-80	Drain Strainer Hook, 80 gallon (300 Liter) Kettle (PN KE51466)		\$365
	SH-100	Drain Strainer Hook, 100 gallon (375 Liter) Kettle (PN KE51467)		\$365
	SH-125	Drain Strainer Hook, 125 gallon (475 Liter) Kettle (PN KE51468)		\$365
		SH-150	Drain Strainer Hook, 150 gallon (575 Liter) Kettle (PN KE51469)	
FS-3		FS3 - 3 Gallon Food Strainer		\$427
FS-6		FS6 - 6 Gallon Food Strainer, Electric, Directs steam Models		\$427
FS-6GAS		FS6 - 6 Gallon Food Strainer, gas models		\$427
FS-12		FS12 - 12 Gallon Food Strainer, Electric, Direct Steam Models		\$427
FS-12GAS		FS12 - 12 Gallon Food Strainer, Gas models		\$427
FS-20		FS20 - 20 Gallon Food Strainer		\$427
FS-25		FS25 - 25 Gallon Food Strainer		\$427
FS-40		FS40 - 40 Gallon Food Strainer		\$1,223
FS-60		FS60 - 60 Gallon Food Strainer		\$1,223
FS-80		FS80 - 80 Gallon Food Strainer		\$3,054
FS-100		FS100 - 100 Gallon Food Strainer		\$3,054
FS-150		FS150 - 100 Gallon Food Strainer		\$3,054
FS-125		FS125 - 125 Gallon Food Strainer		\$3,054
	FS-40SH	FS40SH - 40 Gallon Food Strainer SH Series		\$3,031
	FS-60SH	FS60SH - 60 Gallon Food Strainer SH Series		\$3,031
	FS-80SH	FS80SH - 80 Gallon Food Strainer SH Series		\$3,031
	FS-40SHG	FS40SHG - 40 Gallon Food Strainer SH Series Gas Models		\$3,031
	FS-60HA	FS60HA 60 Gallon Food Strainer For HA Series Mixers		\$3,028
	FS-80HA	FS80HA 80 Gallon Food Strainer For HA Series Mixers		\$3,053
	FS-100HA	FS100HA 100 Gallon Food Strainer For HA Series Mixers		\$3,053
	BS-3	3 Gallon Basket		\$932
	BS-6	6 Gallon Basket		\$984
	BS-12	12 Gallon Basket		\$1,241
	TBS-20	Tri Basket System 20 Gallon Models (Includes Three BS-3'S)		\$3,134
	TBS-25	Tri Basket System 25 Gallon Models (Includes Three BS-3'S)		\$3,323
	TBS-40	Tri Basket System 40 Gallon Models (Includes Three BS-6'S)		\$3,354
	TBS-60	Tri Basket System 60 Gallon Models (Includes Three BS-6'S)		\$4,113
	TBS-80	Tri Basket System 80 Gallon Models (Includes Three BS-6'S)		\$4,113
	TBS-100	Tri Basket System 100 Gallon Models (Includes Three BS-12'S)		\$4,113
	TBS-40SH	Tri Basket System 40 Gallon Models SH Series (Includes Three BS-6'S)		\$4,113
	TBS-60SHGAS	Tri Basket System 60 Gallon Models SH Series Gas (Includes Three BS-6'S)		\$4,113
	TBS-80SH	Tri Basket System 80 Gallon Models SH Series (Includes Three BS-6'S)		\$4,113
	KETTLE ACCESSORY KIT			
	KAK	Kettle Accessory Kit (P/N 40880) Includes All Items Below		\$1,572
	KBK	Kettle Brush Kit (P/N 408802)		\$568
	CB	Clean Up Brush (P/N 00856)		\$146
	KP	Kettle Paddle (P/N 102405)		\$260
	KW	Kettle Whip (P/N 00961)		\$521
	KB	Kettle Brush (P/N 00853)		\$244
	DB	Draw-Off Brush (P/N 00852)		\$146
	KL	Kettle Ladle (P/N 00904)		\$420

ALL KETTLE ACCESSORIES (CONTINUED)

PRODUCT SERIES	MODEL	DESCRIPTION	SHIP WT LBS/KGS	LIST PRICE	
MEASURING STRIPS					
<p>MS</p>	MS-6	6 Gallon Measuring Strip		\$502	
	MS-12	12 Gallon Measuring Strip		\$502	
	MS-20	20 Gallon Measuring Strip		\$502	
	MS-25	25 Gallon Measuring Strip		\$502	
	MS-40	40 Gallon Measuring Strip		\$502	
	MS-60	60 Gallon Measuring Strip		\$502	
	MS-80	80 Gallon Measuring Strip		\$502	
	MS-100	100 Gallon Measuring Strip		\$502	
MISCELLANEOUS					
<p>SF-3</p>	SCK-1	Steam Control Kit - Direct Steam Stationary Kettle (Steam Trap, Strainer, Check Valve)		\$1,138	
	SCK-2	Steam Control Kit - Direct Steam Tilting Kettle, (Steam Trap, Strainer, Check Valve)		\$1,138	
	SCK-3	Steam Control Kit - Direct Steam 200 Gallons (Steam Trap, Strainer, Check Valve)		\$1,138	
<p>SF-3</p>	SF-3	Swing Drain Funnel For Tilting Kettles (KE003891-1, Floor Mounted)		\$790	
	SF-4	Swing Drain Funnel For Stationary Kettles. (KE003891-2, Kettle Mounted)		\$790	
<p>TD-DC</p>	TD-DC	Drain Cup With Hose, For Use With Tangent Draw-Off		\$692	
	ELK	Leg Extensions		\$947	
	TD2A-45	45 Degree Elbow with 8 Foot Hose To Be Used For 2" Tangent With Acme Thread		\$316	
	TD2A-90	90 Degree Elbow with 8 Foot Hose To Be Used For 2" Tangent With Acme Thread		\$328	
	TD3A-45	45 Degree Elbow with 8 Foot Hose To Be Used For 3" Tangent Draw Off or Butterfly Valve with Acme Thread		\$559	
	TD3A-90	90 Degree Elbow with 8 Foot Hose To Be Used For 3" Tangent Draw Off or Butterfly Valve with Acme Thread		\$624	
	KE55336-1	90 Degree Reducer, 3" Acme Tread To 2" Sani Clamp (Tri-Clover) Reducer		\$1,533	
	KE55336-2	90 Degree Reducer, 3" Sani Clamp To 2" Sani Clamp (Tri-Clover) Reducer		\$2,041	
	KE55336-3	45 Degree Reducer, 3" Sani Clamp To 2" Sani Clamp (Tri-Clover) Reducer		\$1,710	
	KE55336-4	90 Degree Elbow, 2" Sani Clamp To 2" Sani Clamp (Tri-Clover) Reducer		\$678	
<p>TD-DC</p>	KE55336-5	45 Degree Elbow, 2" Sani Clamp To 2" Sani Clamp (Tri-Clover) Reducer		\$609	
	KE55336-6	90 Degree Elbow, 3" Acme Thread To 3" Sani Clamp (Tri-Clover)		\$982	
	KE003716-1	KGT6T Nat. To L.P. Conversion Kit 2,000 Ft Elevation, UI Certified		\$837	
	KE003716-2	KGT12T Nat. To L.P. Conversion Kit 2,000 Ft Elevation, UI Certified		\$837	
	KE003716-3	KGL25T Nat. To L.P. Conversion Kit 2,000 Ft Elevation, UI Certified		\$837	
	KE003716-4	KGL60T & Up Nat. To L.P. Conversion Kit 2,000 Ft Elevation, UI Certified		\$837	
	KE003716-5	KGL40T Nat. To L.P. Conversion Kit 2,000 Ft Elevation, UI Certified		\$837	
	WATER METER, WATER COOLING				
	AWC1	Automatic Water Cooling For Direct Steam Kettles (P/N AWC1120/60)			\$6343
	GMC1/LMC1	Water Meter (P/N WM0001)			\$0
SWM	Stand For Water Meter			\$913	

MIXER KETTLES, DIRECT STEAM, VERTICAL SWEEP & FOLD SERIES

STEAM JACKETED MIXER KETTLES

Cleveland Direct Steam Counter Top Mixer Kettle: 2/3 Steam Jacketed, 50 PSI, Two Piece Hinged Cover With Safety Screen, 316 Stainless Steel, Gallon Markings On Mixer Shaft (2 Gal./5 L marks for 12 gal model, 5 Gal, 10 L marks for 20 gal model), Steam Control Valve, Right Side, 115 Voltage Standard, Level Adjustable Legs with Flanged Feet, Certified to Applicable UL, CSA and NSF Standards, CE Certification

PRODUCT SERIES	MODEL	DESCRIPTION	SHIP WT LBS/KGS	LIST PRICE	
 MKDT12T	MKDT12T	12 Gallon (45 Liter) Floor Model Direct Steam Mixer Kettle, Lever Style Hand Tilt	370/186	\$27,962	
	MKDT20T	20 Gallon (80 Liter) Floor Model Direct Steam Mixer Kettle Lever Style Hand Tilt	410/186	\$38,398	
	OPTIONS (BUILT ON AT FACTORY)				
	SLD20	Sliding Drain Drawer With Splash Screen			\$1,514
	240V	208 or 240 Volt Option			\$0
	STM	Steam Valve Left Side Location (Right Side Standard)		\$0	
	SCK2	Steam Control Kit (Steam Trap, Strainer and Check Valve)		\$1,138	
 MKET12T	MKET12T	12 Gallon (45 Liter) Floor Model Electric Mixer Kettle Lever Style Hand Tilt	340/153	\$31,899	
	MKET20T	20 Gallon (80 Liter) Floor Model Electric Mixer Kettle Lever Style Hand Tilt	340/153	\$44,356	
	OPTIONS (BUILT ON AT FACTORY)				
	ELEVATION	Specify Elevation If Above 3,000 Feet			\$0
	VOK1	380 or 415 Volt, 50 Hz, 3 Phase For Electric Export			\$709
	VOK2	440 or 480 Volt, 60 Hz, 3 Phase		\$1,261	
	HW1	High Wattage Standard On MKET Mixer Kettles		\$0	
	SLD20	Sliding Drain Drawer with Splash Screen		\$1,514	
	PCE	Protective Control Cover		\$337	
	CP-MKET	Correctional Packages, MKET (Control Cover, Prison Screws, Prison Screw Driver, Pressure Gauge Guard)		\$1,007	

TILTING SKILLETS, TABLE TOP SERIES

TILT SKILLETS COUNTER TOP ELECTRIC

Cleveland Table Top Tilting Skillets, Self Contained Electric, Marine Style Safety Latch, Heating Elements Cast Into 1.25" Aluminum Block Covers Entire Surface For Even Temperature Distribution, Bead Blasted Cooking Surface Prevents Sticking, Certified to Applicable UL, CSA and NSF Standards, CE Certification

PRODUCT SERIES	MODEL	DESCRIPTION	SHIP WT LBS/KGS	LIST PRICE	
SET10	SET10	10 Gallon (42 Liter) New Mini MVP Tilt Skillet with easyDial Controls and Spring Assist Cover, Manual Lever Tilt with Safety Latch	200/91	\$13,413	
	SET15	15 Gallon (68 Liter) Electric Lever Style Manual Tilt (208 Volt, 3 Phase) (CE)	201/93	\$13,645	
	OPTIONS (BUILT-ON AT THE FACTORY)				
SET10 & ST28	VOSK1	240 Volt, 60 Hz, 3 Phase (For SET Electric Models)		\$0	
	VOSK2	380/415 Volt, 50 Hz, 3 Phase For Export (SET Electric Models)		\$593	
	VOSK3	440-480 Volt, 60 Hz, 3 phase (For SET Electric Models)		\$703	
SET15	SPH	Single Phase Option		\$0	
	TD1.5	1.5" Tangent Draw-Off (for SET10 only)		\$799	
	SET ACCESSORIES				
	SCL15	15 Gallon Left Off Cover Standard On SET15 (standard on SET15)		\$738	
	LCHS15	Lid Holder For SET15		\$236	
	FS15S	Pour Spout Strainer For SET15		\$444	
	F5105	Pour Spout Strainer for SET10 (KE603841)		\$776	
	SPK24	Single Pantry Faucet & Bracket For SET10		\$600	
	DPK24	Double Pantry Faucet & Bracket For SET10		\$776	
	SPK16	Single Pantry Faucet & Bracket For SET15		\$600	
	DPK16	Double Pantry Faucet & Bracket For SET15		\$776	
	B0176	T&S Double Pantry Faucet with Swing Spout and PRS Spray Hose		\$1,778	
	SKFS	Single Pantry Faucet Skillet Filler wotj 60" hose (P/N 105978)		\$1,379	
	DKFS	Double Pantry Faucet Skillet Filler with 60" hose (P/N 105979)		\$1,704	
	PRSS	Pre-Rinse Spray Hose (B-0113)		\$1,787	
FBS-SET15T	Faucet Bracket SET15		\$272		
FBS-SET10T	Facet Bracket SET10		\$272		
FSSK	Food Strainer 30/40 Gallon skillets (P/N KE603840)		\$435		
VS	Vegetable Steamer (1 each for SET10 and SET15)		\$898		
FS15S	For Strainer for SET15		\$444		
PP	Poaching Pan (Pan SK2242000) folds one for SET10		\$842		
PPR	Poaching Pan (SET15) (P/N 2241300) holds one for SET15		\$1019		
MS-15	15 Gallon Measuring strip for SET15		\$559		
BSSSET15	Pasta Basket For SET15		\$1,283		

ST SERIES EQUIPMENT STANDS

Heavy Stainless Steel Construction With 1-1/4' Square Tubing, Adjustable Feet, (Rear Flanged Feet For Bolting To Floor) Standard With Sliding Drain Drawer And Splash Screen, Can Be Hard Piped To Floor Drain, Certified to Applicable UL, CSA and NSF Standards

PRODUCT SERIES	MODEL	DESCRIPTION	SHIP WT LBS/KGS	LIST PRICE
EST28G	EST28G	28" Wide Economy Equipment Stand, No Drain Drawer For Single Skillet		\$1,569
	ST28G	28" Wide Equipment Stand W/ Drain Drawer And Splash Screen For Single Skillet		\$2,589
ST28G	ST55G	55" Wide Equipment Stand W/ Drain Drawer And Splash Screen (For SET10, Or Two SET15)		\$4,854
	SG-28G	Large Flow Folding Splash Guard For ST28, ST55		\$276
ST55G	100413	Flanged Foot for equipment stands (two rear flanged feet standard, front to bullet style)		\$65

TILTING SKILLETS, FLOOR MODEL, TR SERIES "DURAPAN"

TILT SKILLETS TR DURAPAN SERIES

Cleveland Durapan TR Series Tilt Skillet, Front Hinge Style Tilting Skillet, Hydraulic Hand Tilt With Quick Lowering Feature, Bead Blasted Cooking Surface Prevents Sticking, Solid State "Imbedded" Temperature Thermostats For Even Temperature Distribution, Water Resistant Controls, 100 - 425 F, Temperature Control Knob, Stainless Steel Gas Burners on gas models, Reinforced Rolled Rim Eliminates Pan Warping, Vented Spring Assist, Certified to Applicable CSA and NSF Standards, CE Certification and Australian Approvals for Gas TR Models

PRODUCT SERIES	MODEL	DESCRIPTION	SHIP WT LBS/KGS	LIST PRICE
	SGL30TR	30 Gallon (117 Liter) Gas Manual Tilt - Open Base	498/227	\$24,113
	SGL40TR	40 Gallon (156 Liter) Gas Manual Tilt - Open Base	622/318	\$26,088
	SEL30TR	30 Gallon (117 Liter) Electric Manual Tilt - Open Base	485/220	\$18,853
	SEL40TR	40 Gallon (156 Liter) Electric Manual Tilt - Open Base	620/282	\$20,910
OPTIONS (BUILT-ON AT THE FACTORY)				
      	GM1	Gallon and Liter Markings Standard		\$0
	LPG	LP Gas		\$0
	ELEVATION	Gas Models Specify Elevation If Over 2,000 Feet		\$0
	SLD	Sliding Drain Drawer With Splash Screen (Pour Spout moves to left side if No Tangent Draw-Off is ordered, SGL/SEL-TR Models Only)		\$1,553
	SGSLD-TR	Folding Splash Guard For TR Tilt Skillet Drain Drawer (For heavy pours)		\$254
	TDS2K	2" Tangent Draw Off With Drain Strainer, mounted on left side (Pan Carrier Not Available On 30 Gal. Models)		\$839
	PT2	Power Tilt With Manual Override Option		\$589
	VOSK1	240 Volt, 60 Hz, 3 Phase (Specify For SEL Electric Models)		\$0
	VOSK2	380/415 Volt, 50 Hz, 3 Phase For Export (SEL Electric Models)		\$703
	VOSK3	440/480 Volt, 60 Hz, 3 Phase (For SEL Electric Models)		\$703
	VOSK4	220/240 Volt, 50 Hz, 1 Phase For Export (For SGL Gas Models)		\$703
	CPPCBTR	Protective Control Cover		\$497
	CP-SKTD	Prison Package For Tilt Skillets (See Page 49 for Details)		\$1,488
	TR SERIES ACCESSORIES			
	FSSK	Pour Spout Strainer		\$435
	DPK14	Double Pantry Faucet & Bracket For SEL/SGL-TR Series		\$776
	SPK14	Single Pantry Faucet & Bracket For SEL/SGL-TR Series		\$600
	PCS	PCS - Pan Carrier (Not Available On 30 Gallon With 2" Tangent) (2240099)		\$858
	QDC60	5 Foot Long 3/4" Gas Quick Disconnect Hose (P/N 1007841)		\$902
	B0176	T&S Double Pantry Faucet with Swing Spout and PRS Spray Hose		\$1,778
	SKFS	Single Pantry Faucet Skillet Filler wotj 60" hose (P/N 105978)		\$1,379
	DKFS	Double Pantry Faucet Skillet Filler with 60" hose (P/N 105979)		\$1,704
	PRSS	Pre-Rinse Spray Hose (B-0113)		\$1,787
	FBS-TR	Facet BRacket TR Series Skillets		\$272
	PP	Poaching Pan (Pan SK2242000)		\$842
	VS	Vegetable Steamer (1 each for SET10 and SET15)		\$898
	DRAINPAN6	6" Deep 12" X 20" Stainless Steel Pan with Drain		\$568
	FFSTR	Front Flanged Feet for TR Series Skillets (SK00414-) Flanged Foot, SK078160160-1 Insert		\$145
	SSLD-30TR	Sliding Drain Drawer Field Install Kit For 30 Gallon SGL/SEL-TR Models (Must Have 2" Tangent Draw-Off Or Pour Spout On Left Side)		\$732
	SSLD-40TR	Sliding Drain Drawer Field Install Kit For 40 Gallon SGL/SEL-TR Models (Must Have 2" Tangent Draw-Off Or Pour Spout On Left Side)		\$801

TLTILTING SKILLETS, FLOOR MODEL, T1 SERIES "POWERPAN"

TILT SKILLETS T1 POWERPAN SERIES

Cleveland PowerPan T1 Series Tilt Skillet, Center Trunnion Style Tilting Skillet, Gear Style Hand Tilt, All Stainless Steel Construction Including Gas Burners (gas models), Bead Blasted Cooking Surface Prevents Sticking, Solid State "Imbedded" Temperature Thermostats For Even Temperature Distribution, EDC Controls (cook ON, Cook OFF, Cook Hold and Cooking with Product Probe), 100 - 425 F Temperature Control Knob, Reinforced Rolled Rim Eliminates Pan Warping, Vented Spring Assist Cover, System Gas Models Feature Patented Forced Air Gas Combustion System with Dual Power Control With Standard And Turbocharged Power Settings, Certified to Applicable UL, CSA and NSF Standards, CE Certification

PRODUCT SERIES	MODEL	DESCRIPTION	SHIP WT LBS/KGS	LIST PRICE
	SGL30T1	30 Gallon (117 Liter) Gas Manual Tilt	520/237	\$25,640
	SGL40T1	40 Gallon (156 Liter) Gas Manual Tilt	610/277	\$27,609
	SEL30T1	30 Gallon (117 Liter) Electric Manual Tilt, IPX6 Water Rated	390/178	\$19,460
	SEL40T1	40 Gallon (156 Liter) Electric Manual Tilt, IPX6 Water Rated	645/187	\$21,211
T1 SERIES TILT SKILLET OPTIONS				
	GM1	Gallon and Liter Markings Standard		STD
	LPG	LP Gas		\$0
	ELEVATION	Gas Models Specify Elevation If Over 2,000 Feet		\$0
	EZD	EasyDial Control Option		\$1,111
	TCP1	Core Temperature Probe, EasyDial Controls Only (KE604132-1)		\$731
	FF	Level Adjustable Flanged Feet For Floor Bolting Standard		STD
	TDS2K	2" Tangent Draw Off With Drain Strainer, mounted on left side		\$839
	PT2	Power Tilt With Manual Override Option		\$589
	VOSK1	240 Volt, 60 Hz, 3 Phase (For SEL Electric Models)		\$703
	VOSK2	380/415 Volt, 50 Hz, 3 Phase For Export (SEL Electric Models)		\$703
	VOSK3	440-480 Volt, 60 Hz, 3 Phase (For SEL Electric Models)		\$703
	VOSK4	220/240 Volt, 50 Hz, 1 Phase For Export (For SGL Gas Models)		\$703
	HWS	High Wattage Option (16 Kw For 30 Gal, 24 Kw For 40 Gal) SEL-T1 Electric Models		\$9460
	CPPCBTR	Protective Control Cover		\$497
	CP-SKTD	Prison Package For Tilt Skillets (See Page 49 for Details)		\$1488
	T1 SERIES ACCESSORIES			
	FSSK	Pour Spout Food Strainer (P/N KE603840)		\$436
	DPK29	Double Pantry Faucet & Bracket For SEL/SGL-T1 Series		\$776
	SPK29	Single Pantry Faucet & Bracket For SEL/SGL-T1 Series		\$600
	2499999	PCS - Pan Carrier (Not Available On 30 Gallon With 2" Tangent) (SK24499999)		\$858
	308787	Casters, Set Of Four, Two Locking (P/N 0308787)		\$878
	QDC60	5 Foot 3/4" Long Gas Quick Disconnect Hose (P/N 1007841)		\$902
	B0176	T&S Double Pantry Faucet Skillet Filler with Swing spout and PRS Spray Hose		\$1,778
	SKFS	Single Pantry Faucet Skillet Filler with 60" hose (P/N 105978)		\$1,379
	DKFS	Double Pantry Faucet Skillet Filler with 60" hose (P/N 105979)		\$1,704
	PRSS	Pre-Rinse Spray Hose (B-0113)		\$1,787
	PP	Poaching Pan (SK2242000) 30 gallon model holds 2, 40 gallon model holds 3		\$842
	VS	Vegetable Steamer (2 ea. for 30 gal, 3 ea. for 40 gal)		\$898
	DRAINPAN6	6" deep 12"x20" stainless steel pan with drain		\$1,135
	FBS-T1	Faucet Bracket for T1 Series skillets		\$272
	KE01173-5	Extended legs 5"L 1-14" Pipe for T1 Skillet only (P/N KE01173-5)		\$150
	KE01173-6	Extended legs 6"L, 1-14" Pipe for T1 Skillet only (P/N KE01173-6)		\$150
	FFST1	Front mounted flanged feet for T1 series skillets only (KE50249-2)		\$624

SGL40T1

EZD

DPK

PCS

TILTING SKILLETS ACCESSORIES

MODEL	DESCRIPTION	SHIP WT LBS/KGS	LIST PRICE
LIFT OFF COVERS, COVER HOLDERS			
SCL10	Lift off cover fro SET10		\$982
SCL15	Lift Off Cover For SET15		\$738
LCH15	Lift Off Cover Hold SET15		\$236
MISCELLANEOUS			
SSLD-30TR	Sliding Drain Drawer Field Install Kit For 30 Gallon SGL/SEL-TR Models (Must Have 2" Tangent Draw-Off Of Left Side)		\$732
SSLD-40TR	Sliding Drain Drawer Field Install Kit For 40 Gallon SGL/SEL-TR Models (Must Have 2" Tangent Draw-Off On Left Side)		\$801
SGSLD-TR	Folding Splash Guard For TR Tilt Skillet Drain Drawer		\$259
0308787	Caster Set For T1 Series Skillets - P/N 0308787		\$877
FFSTR	Front Flanged Feet For TR Series Skillets (SK00414-1 Flanged Foot, SK078160-1 Insert)		\$145
FFST1	Front Mounted Flanged Feet For T1 Series Skillets Only (KE50249-2)		\$624
KE01173-4	Extended Legs 4"L, 1-14" Pipe For T1 Tilt Skillets Only (P/N KE01173-4)		\$151
KE01173-5	Extended Legs 5"L, 1-14" Pipe For T1 Tilt Skillets Only (P/N KE01173-5)		\$150
KE01173-6	Extended Legs 6"L, 1-14" Pipe For T1 Tilt Skillets Only (P/N KE01173-6)		\$150
KE003716-6	SGL30TR Nat. To L.P. Conversion Kit 2,000 Ft Elevation, UL Certified		\$837
KE003716-7	SGL40TR Nat. To L.P. Conversion Kit 2,000 Ft Elevation, UI Certified		\$837
KE003716-9	SGL40T1 Nat. To L.P. Conversion Kit 2,000 Ft Elevation, UL Certified		\$838



SCL10

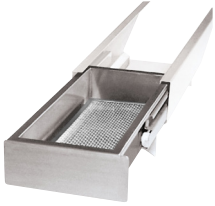

SSLD-30TR

MODEL NUMBER LEGEND



POSITION 1

(followed by dash)

Width of cabinet base in inches for Counter Type Convection steamers, Floor Model Convection steamers, ConvectionPros. (Not used for Kettles, or Skillet)

POSITION 1

TYPE OF EQUIPMENT:

C = **C**onvection Steamer

K = **K**ettle

C = **C**onvection Steamer

S = **S**killet

P = **P**ressure Steamer

PC = **P**ressure / **C**onvection Steamer

MFS = **M**etering **F**illing **S**tation

MK = **M**ixer **K**ettle

TMK = **T**win **M**ixer **K**ettle

HA-MK = **H**orizontal **A**gitator **M**ixer **K**ettle

POSITION 3

TYPE OF POWER OR ENERGY SOURCE:

E = **E**lectricity

G = **G**as — natural — other, if specifically identified

D = **D**irect steam (connected to a separate source)

S = **S**tream **C**oil **G**enerator — use where steam available from another source is not clean enough to use on food (Only one size exists).

POSITION 4

TYPE OF MOUNT OR GENERATOR:

L = **L**egs, open stand or frame

P = **P**ressure generator

M = **M**odular; cabinetized; enclosed

T = **T**able top mounted on stand cabinet, table, counter, etc.

A = **A**tmospheric generator (stainless steel)

POSITION 5

Designation of capacity or input. For kettles, it will indicate "Gallons." For electric or gas steam generators, it will indicate input of energy in either "KW" or "M BTU." (Number is preceded by a dash). For SteamCraft Series this number will indicate the pan capacity for 2-1/2" steam table pans.

POSITION 6

(followed by dash)

ADDITIONAL DETAILED INFORMATION OR ACTION:

F = Indicates a **F**ull steam jacket on a kettle.

T = Indicates a **T**ilting kettle, either manual or power pour.

EXAMPLES OF MODEL NUMBER USAGE

36-CGM-200 is a 36 inch wide base, Convection Steamer, Gas powered, Modular cabinet mounted, 200M BTU.

or:

TMKEL-100-T is a Twin Mixer-Kettle, Electric, Leg mounted, 100 Gallon, Tilting. But, being a twin kettle model, it has two 100 Gallon kettles.

NOTE: Model Number Legend not valid for Options and Accessories.

STEAMCRAFT 3, 5, 10 & GEMINI™ CONVECTION STEAMERS
 GENERATOR STYLE, IDEAL FOR HIGH VOLUME A LA CARTE AND BATCH TYPE

SteamCraft®
 Series High
 Speed Convection
 Steamers

“When you need a lot and need it fast”.



SteamCraft® 5

Cooking Capacity for up to ten 12" x 20" x 2 1/2" deep Cafeteria Pans, five each compartment.

Totally independent cooking compartments, each has its' own generator, gas valve and water level controls - no shared components

- Exclusive High Efficiency Gas Power Burner (forced air) Generator: Produces more steam for faster cooking while lowering operating costs (72M BTU's per compartment)
- Easy Access Cleaning Port: Each generator has a delimiting port located on the outside, top of the unit
- Generator Cleaning Light for each compartment warns the operator to delime generator
- Generator Steam Standby Mode: Holds generator at a steaming temperature, allows unit to start cooking quickly
- Each compartment has one, 60-Minute Electro-Mechanical Timer with "SureCook" load compensating feature. Manual Bypass Switch for constant steaming.
- Durable Heavy Gauge, 304 Stainless Steel construction for compartment door, cooking cavity and steam generator
- Exclusive Two-Piece Compartment door: Slammable, self-adjusting door provides and airtight seal, reversible door gasket for extended life
- Exclusive Gemini™ Drain/Power Control System: Simple, reliable 1/2" ball valve style drain automatically turns power ON/OFF
- Exclusive Brass Steam Jets distribute even, high velocity steam throughout cooking compartment for faster cooking times
- Easy, Front -Access Generator Controls comes with a pullout drawer for simple servicing of unit
- Compartment Steam Shut-Off Switch when compartment door is opened



SteamCraft® Gemini™ 10



Connectionless Model
22CCT6



Connected Electric Model
22CET3.1 22CET6.1



Connected Gas Model
22CGT3.1 22CGT6.1



Easy as 3-2-1...

3-YEAR COMPARTMENT DOOR WARRANTY STANDARD

- Rugged 14-gauge stainless steel holds up to abuse.
- Heavy gauge door hinges maintains tight leak proof seal.

2-PIECE EXCLUSIVE COMPARTMENT DOOR DESIGN

- "Free Floating" inner door is self adjustable, maintains steam tight seal.
- Removable for easy cleaning and sanitizing, stays "Cool to the Touch".

1-YEAR DOOR GASKET WARRANTY STANDARD

- Door gasket last "4-Times Longer" than competitive models.

... Plus

PATENTED KLEANSHIELD COOKING COMPARTMENT DESIGN

- Provides "Clean Steam" - eliminates foaming and cross contamination.
- Eliminates flavor transfer, easy to clean and sanitize.

EXCLUSIVE CONVECTION STYLE BAFFLE SYSTEM

- High velocity "Convection Steam" for even energy distribution.
- Faster cooking and recovery times for superior performance.



22CCT6:
6 Pan Electric Connectionless

SteamChef's patented **KleanShield** compartment design eliminates foaming, flavor transfer and cross contamination caused by the water reservoir typically found in connectionless steamers.

NOW MEET EPA 202
For Ventless Operation
(Electric Models)



Typical Connectionless Steamer



Steam generating water from SteamChef with **KleanShield** (left) and typical connectionless steam water (right) after 3 loads of potatoes.



21CET8



21CET16

When You Need A Lot and Need it Fast!

MAINTENANCE FREE "STEAM JETS" FOR HIGH VELOCITY STEAM.

- No fans needed, superior temperature distribution, fast cooking, instant recovery and maintenance free.

SELF CLEANING FIREBAR STYLE ELEMENT

- Shed's off scale and improves energy efficiency

EXCLUSIVE "DRYING ELEMENT" FOR MOISTURE-FREE STEAM

- No flavor transfer or cross contamination

TWO-PIECE COMPARTMENT DOOR

- Self adjusting free floating inner for air-tight seal
- Reversible door gasket, quadruples the life of the gasket.

Best Overall Warranty Program

5-YEAR PRORATED GENERATOR WARRANTY

3-YEAR EXCLUSIVE STEAMER DOOR WARRANTY

- Full 3-years parts and labor coverage on 3, 5, 6 & 10 Pan Models

3-YEAR K-12 SCHOOL WARRANTY ON STEAMER WITH FILTER PURCHASE

- 2-Year K-12 standard warranty Steamers, Kettles, Skillets.

2-YEAR STEAMER WARRANTY WITH FILTER PURCHASE

- Full 2-years parts and labor coverage.

1-YEAR STEAMER DOOR GASKETS AND ADJUSTMENTS

- 3, 5, and 6 compartment steamers.

FREE PERFORMANCE START UP INCLUDED

- Water Quality Lab Analysis available for "FREE".

GEMINI 10 CONVECTION STEAMERS HEAVY GAUGE STAINLESS STEEL GENERATORS



10-Pan Models:

- 24CGA10 – Twin systems
- 24CGA10.2 – Energy Star
- 24CGA10.2ES – Single generator system
- 24CEA10.2 – Electric model

TWIN INDEPENDENT COOKING COMPARTMENTS

- Separate generator, gas combustion system, water level control and cooking controls for each compartment.

HIGH EFFICIENCY “TURBO-CHARGED” GAS POWER BURNER DESIGN

- For increased steam production, cooking speed and recovery.
- Approved for use over combustible floors.

SINGLE FRAME UNIBODY CONSTRUCTION DESIGN

- Heavy gauge stainless steel single frame construction holds up to abuse, allows for proper airflow, reducing downtime.

MAINTENANCE FREE “STEAM JETS” FOR HIGH VELOCITY STEAM

- No fans needed, superior temperature distribution, fast cooking and instant recovery.

REMOTE WATER LEVEL CONTROLS

- Located outside the generator for simplified maintenance and service.

TWO-PIECE COMPARTMENT DOOR

- Self adjusting free floating inner for air-tight seal
- Reversible door gasket, quadruples the life of the gasket.

5-YEAR PRORATED GENERATOR WARRANTY

3-YEAR EXCLUSIVE STEAMER DOOR WARRANTY

- Full 3-years parts and labor coverage.

3-YEAR K-12 SCHOOL WARRANTY ON STEAMER WITH FILTER PURCHASE

- 3-Year K-12 standard warranty Steamers, Kettles, Skillets.

1-YEAR STEAMER DOOR GASKETS AND ADJUSTMENTS

- 3, 5, and 6 compartment steamers.

FREE PERFORMANCE START UP INCLUDED

- Water Quality Lab Analysis available for “FREE”.

CLASSIC SERIES STEAMERS 15 PSI BOILERS, GAS & ELECTRIC MODELS



Model 24CGM200

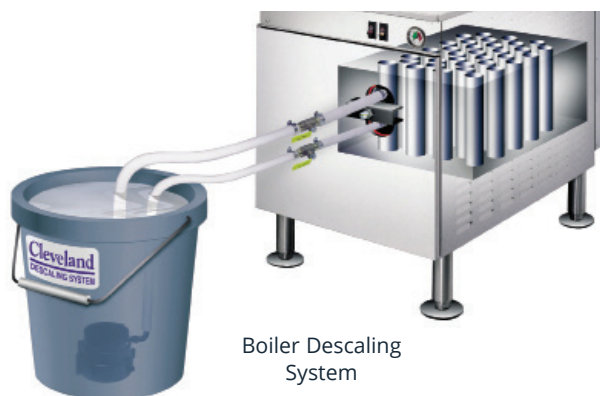

Boiler Descaling System

INDUSTRY'S BEST WARRANTY

- 5-year prorated boiler warranty featuring nickelguard boiler protection.
- 3-year 100% k-12 school warranty with filter purchase.
- 3-year door warranty.
- 1-year door gasket warranty.

EXCLUSIVE TWO-PIECE DOOR DESIGN

- Two-piece compartment door with free floating inner door provides air-tight, leak proof seal.
- Reversible, rotatable door gasket extends life 4 times longer than competitors.
- Cool to the touch, won't burn operators.

HEAVY 14-GAUGE STAINLESS STEEL CONSTRUCTION

- Build for life design with heavy duty 14-gauge stainless construction for cooking compartment, door and base frame.

EASIER MAINTENANCE

- Optional boiler descaling pump system simplifies descaling, saving time while providing improved safety and superior cleaning results.



5-YEAR PRORATED BOILERS AND GENERATOR WARRANTY

- 100% covered for first 2 years with filter purchase.

3-YEAR EXCLUSIVE STEAMER DOOR WARRANTY

- Full 3-years parts and labor coverage on 3,5,6, 10 Pan Models.

3-YEAR K-12 SCHOOL WARRANTY ON STEAMER WITH FILTER PURCHASE

- 3-Year K-12 standard warranty Steamers, Kettles, Skillets.

2-YEAR STEAMER WARRANTY WITH FILTER PURCHASE

- Full 2-years parts and labor coverage.

1-YEAR STEAMER DOOR GASKETS AND ADJUSTMENTS

- 3, 5, and 6 compartment steamers.

FREE PERFORMANCE START UP INCLUDED

- Water Quality Lab Analysis available for "FREE".

**See warranty policy for details.*



ELECTRIC, GAS & DIRECT STEAM KETTLES
50 PSI HIGH PRESSURE STEAM JACKET RATING (3.5 BAR BOILING PANS)

**Cleveland
 Steam
 Jacketed
 Kettles**

Set the Standard
 for Comparison



Gas Kettles



Electric Kettles



**BLUE FLAME AWARD
 RECIPEINT 2023**

Gas Kettles

- Rotatable, domed cover with spring assist for easy cleaning.
- Sealed roller bearing pivot for easy tilting and longer life than brass bushings.
- 50 PSI (3.5 Bar) Steam Jacket Rating for higher temperatures and faster cooking and superior browning.
- Easy to replace O-ring gasket on tangent stem.
- High-efficiency power burner (on Gas models), provides efficient heat transfer, making for extremely fast heat-up and recovery with economical gas consumption.
- Hardened, adjustable tilt gears for long life and easy tilting.
- Water resistant controls and splash-proof design prevent water damage from spillage or cleaning.
- Solid State Temperature controls are accurate to within 1 C, and do not wander; perfect for delicate products and tightly controlled simmering.
- Additional leg, (4 total) on electric models with 80 gallon+ capacity for greater stability (all gas models come standard with 4 legs).

Electric Kettles

- Rotatable, domed cover with spring assist for easy cleaning.
- Sealed roller bearing pivot for easy tilting and longer life than brass bushings.
- 50 PSI (3.5 Bar) Steam Jacket Rating for higher temperatures and faster cooking and superior browning.
- Easy to replace O-ring gasket on tangent stem.
- IPX6 rated controls and splash-proof design prevent water damage from spillage or cleaning.
- Solid State Temperature controls are accurate to within 1 C, and do not wander; perfect for delicate products and tightly controlled simmering.
- Hardened, adjustable tilt gears for long life and easy tilting.
- Additional leg, (4 total) on models with 80 gallon+ capacity for greater stability.

STEAM JACKETED KETTLE BENEFITS

50 PSI HIGH PRESSURE STEAM JACKET RATING (3.5 BAR BOILING PANS)



Stow Away your Stock Pots and Get Cooking with Steam

Cleveland steam jacketed kettles offer ultra efficient heat transfer, uniform heating and superior product handling. Steam jacketed kettles offer faster cooking times because two thirds of the cooking surface comes into contact with the product at a much lower temperature, compared to stock pots that use a much higher temperature only at the bottom of the pot. In addition, accurate temperature controls eliminate constant monitoring and resetting. Foods won't burn or scorch and you can hold product at a simmer without over cooking. Tilting models makes product handling simple. Clean up is easy since food isn't burned or over cooked like stock pots.

IDEAL FOR:

Soups, delicate sauces, pasta, gravies, desserts, stews, braising meats, rice, reheating dishes and holding them until serving.

INCREASES QUALITY AND PRODUCTIVITY:

- Heats from all sides and has 3-4 times larger heat surface than stock pots.
- Gentle uniform cooking.
- Faster cooking times using high energy steam.
- Precision temperature controls from a simmer to a rolling boil.
- No hot spots.
- Eliminates pot watching, constant stirring and large stock pots.

IMPROVES OPERATOR'S PROFITS BY:

- Reduces food waste due to over cooking and burning.
- Reheat meals without over cooking.
- Simmer food all day without over cooking.
- Simplifies and standardizes recipe and enhances recipe development.
- Improves Worker Safety:
 - Tilting models make pouring safe.
 - Eliminates heavy lifting and carrying hot stock pots.

SAVES ENERGY:

Kettles use 35% less energy than stock pots on an open burner. Keeps kitchens cooler.

SAVES TIME:

- Eliminates scrubbing of messy stock pots.
- Butterfly shaped pouring lip accurately pours product into containers for serving.



KET-3-T TKET-3-T
 KET-6-T KET-6-TGB TKET-6-T
 KET-12-T KET-12-TGB TKET-12-T

- MEETS IPX6 WATER RATING PROTECTION GUIDELINES**
- Meets IPX6 for both standard and easyDial controls models.
 - Prevents downtime and expensive water related damages.

- BUILT IN SELF DIAGNOSTICS STANDARD**
- 6 diagnostic error codes continuously monitors internal functions.
 - Easy to service, promotes first time fix rates.

- ENERGY EFFICIENT LOW WATT DENSITY HEATING ELEMENTS**
- Low watt density element extends element life longer
 - 100% vacuum sealed, no gaskets requires, leaks eliminated, no element failures.

- COLOR CODED PRESSURE VACUUM GAUGE**
- Green zone allows operators to easily identify kettle vacuum for optimum performance.
 - Vent air zone easily identifies when vacuum is lost.

- "MARINE STYLE" SAFETY LATCH STANDARD**
- Built in safety latch prevents accidental spills.

- SOLID STATE TEMPERATURE CONTROLS**
- Less than 5° F (1° C) temperature variance for superior cooking control from simmering to rapid boil, no burning or scorching.

New easyDial® Control Option

- Digital time and temperature control and indicator.
- Three cooking modes — Cook/Simmer, Cook/Off, Cook/Cook.
- Meets IPX6 water rating protection guideline.
- Six built in diagnostic indicator readouts.
- Optional core temperature probe.
- Available on KET, KGT Series countertop self contained kettles.



Model KGL40T
(40 Gallon Tilting)



Model KGL40SH
(Short Series Stationary)



MOST POWERFUL GAS KETTLE AVAILABLE*

- 160,000 BTU's on 40-gallon models.
- 190,000 BTU's on 60, 80, 100-gallon models.
- 50 PSI steam jacket rating achieves high temperatures.

PATENTED "TURBO CHARGED" GAS HEATING DESIGN

- High efficiency patented forced air gas combustion system.
- Fastest in cooking speed and recovery.
- Boils up to 40% faster than competitors.
- Certified for use over combustible floors.

BUILT-IN SELF DIAGNOSTICS STANDARD

- 6 diagnostic error codes continuously monitors internal functions
- Easy to service, promotes first time fix rates
- Color Coded Pressure Vacuum Gauge
- Green zone allows operators to easily identify kettle vacuum for optimum performance.
- Vent air zone easily identifies when vacuum is lost.

SOLID STATE TEMPERATURE CONTROLS

- Less than 5° F (1° C) temperature variance for superior cooking control from simmering to rapid boil, no burning or scorching.

BLUE FLAME AWARD RECIPIENT 2023

New easyDial® Control Option (For Tilting Models Only)

- Digital time and temperature control and indicator.
- Three cooking modes — Cook/Simmer, Cook/Off, Cook/Cook.
- Meets IPX6 water rating protection guideline.
- Six built in diagnostic indicator readouts.
- Optional core temperature probe.
- Available on KET, KGT Series countertop self contained kettles.



TANGENT DRAW OFF VALVE

- Comes out the front of the kettle.
- 2" or 3" diameter size outlets.
- GOOD for pumping, only way to pump on electric models since Butterfly and Air Piston Valve not available on electric kettles.



Tangent Draw-Off with Acme Thread

3" BUTTERFLY VALVE

- Comes out the bottom of the kettle.
- BETTER for pumping since locate on bottom of kettle.
- Available on gas and direct steam, not available on electric kettle.



3" Butterfly Valve with Sani Style (Tri Clover) Clamp

3" AIR PISTON VALVE

- Air operated piston opens/closes on the bottom of the kettle, flush mounted at the bottom for Air-Tight Seal.
- BEST method for pumping.
- Available on gas and direct steam, not available on electric kettles.

TYPES OF CONNECTIONS FOR PUMPING

1. Sani Clamp (Tri Clover Clamp): Drain Valve is flanged on the bottom, Tri-Clover clamp used to connect hose to valve, easiest of the connections to attached and clean, accepted in USDA facilities.
 2. Acme Thread: Large threads on end of valve to screw on hoses. Very cleanable and accepted in USDA facilities
- When pumping, specify Sani Clamp or Acme Thread options, must be built on at factory.



3" Air Piston Valve with Acme Thread (Kettle bottom with valve in closed position)

MODEL SF3 FOR TILTING KETTLES

- For Use With Kettles With a 2" Tangent Draw Off Valve.
- Swivel Style Drain Cup Swings Under Or Away from Tangent Draw Off Valve Opening.
- Includes Drain Screen.
- Mounts To Leg Of The Kettle.
- Can Hard Piped to Floor Drain.
- Heavy Stainless Steel Construction.



SF3 Swing Drain Funnel for Tilting Kettles

MODEL SF4 FOR STATIONARY KETTLES

- For Use With Kettles With a 2" Tangent Draw Off Valve.
- Swivel Style Drain Cup swings Under Or Away from Tangent Draw Off Valve Opening.
- Includes Drain Screen.
- Mounts To Leg Of The Kettle.
- Can Be Hard Piped to a Floor Drain.
- Heavy Stainless Steel Construction.

SF4 Swing Drain Funnel for Stationary Kettles



PAN CARRIER - MODEL PCK

- Made from heavy gauge stainless steel. Bracket under pour spout connects Pan Carrier, for all Cleveland floor model tilting kettles.
- Stays level when kettle is tilted, allows the product to be poured directly in 12" x 20" pans.
- Pan Carriers and Flow Diverter for Tilting Kettles

FLOW DIVERTER- MODEL FD

- Made from heavy gauge stainless steel.
- Bracket under pour spout connects Flow Diverter, for all Cleveland floor model tilting kettles.
- Hinged style diverter allows operator to accurately direct pour when tilting with to minimize splashing.



Model PCK Pan Carrier when tilted

Model FD Pan Flow Diverter when tilted

GAS & ELECTRIC TILTING BRAISING PANS
 HIGH PRODUCTIVITY, UNMATCHED PERFORMANCE — THE WORKHORSE OF THE KITCHEN

Cleveland Braising Pans

Value-Added Features Built Into Every Model.

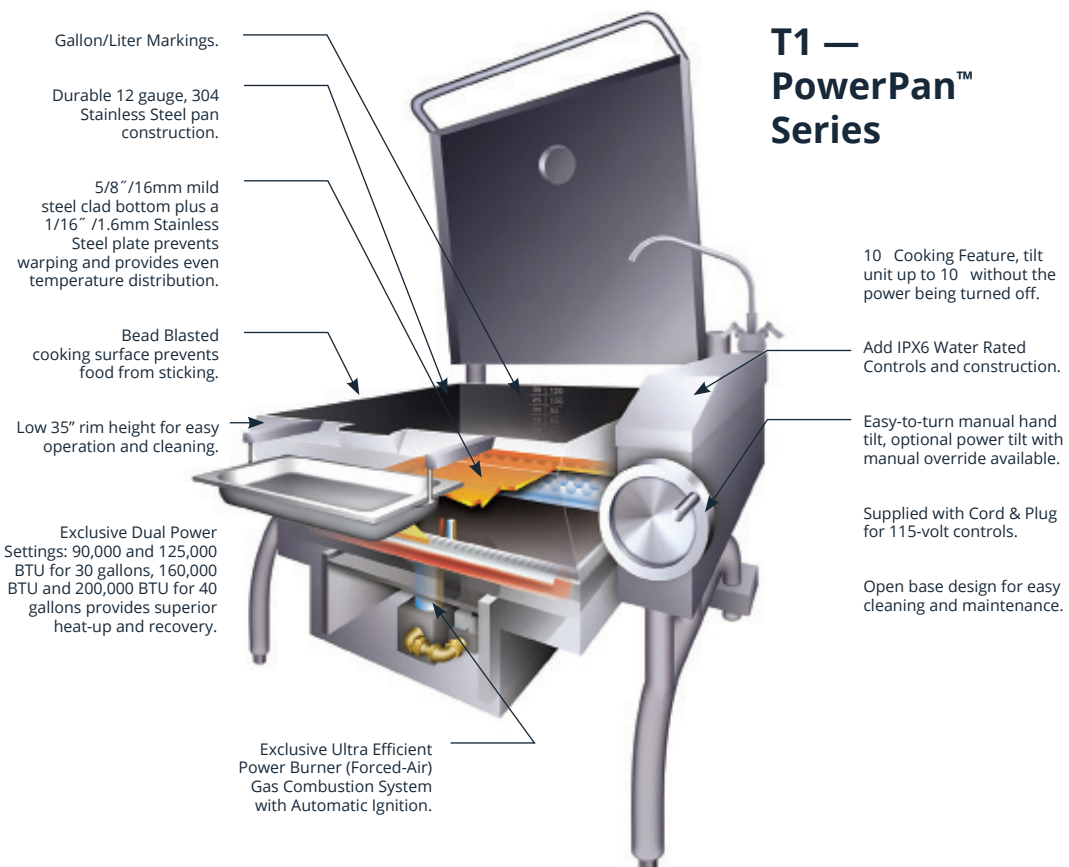

T1 — PowerPan™ Series



SET10



SET15



SEL40TR
 Shown with Sliding Drain Pan (SLD)



SGL40T1

Superior Temperature Control

IMBEDDED TEMPERATURE SENSORS

- "Imbedded" temperature sensors drilled into pan bottom for precise even cooking (see comparison below).

MULTIPLE STAINLESS-STEEL BURNER DESIGN

- Large stainless-steel burners with "multiple rows of rosette's.
- Evenly spaced throughout the pan bottom for quick response and greater temperature control and even browning pattern.

HYDRAULIC HAND TILT WITH QUICK LOWERING FEATURE

- Easy to turn hydraulic hand tilt requires fewer turn.
- Quick Lowering feature eliminates hand tilting down.

MEETS IPX6 WATER RATING PROTECTION GUIDELINES

- Meets IPX6 for both standard and easyDial controls.
- Prevents downtime and expensive water related repairs.

REINFORCED ROLLED RIM

- Eliminates warping of skillet pan allowing skillet cover to close properly.

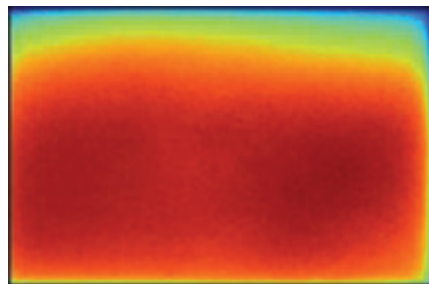

Cleveland **SGL40TR**

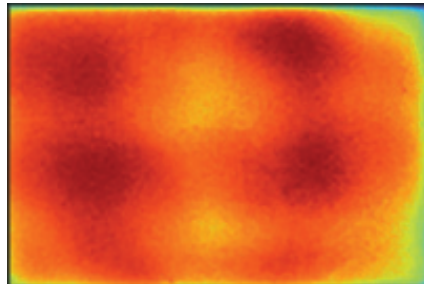

Competitor A

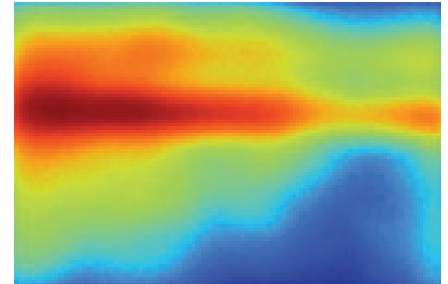

Competitor B

Results of thermal imaging testing on three leading tilt skillets surfaces heated to 350°F.

COMPARE THE DIFFERENCE

Cleveland solid state temperature control sensors are "drilled" into the skillet's surface and provides an even temperature across entire pan surface, eliminating hot and cold spots for better browning pattern. Competitors clamped on version has a wider temperature variance which causes greater uneven temperatures across the pan surface.

T1 — POWERPAN SERIES TILT SKILLETS SGLT-1, SEL-T1 SERIES

More Power, Speed And Recovery

MOST POWERFUL TILT SKILLET AVAILABLE*

- Up to 60% more power on 30 gallon models.
- Up to 100% more power on 40 gallon models.

PATENTED "TURBO CHARGED" GAS HEATING DESIGN

- High efficiency forced air gas combustion system.
- Fastest in cooking speed and recovery.

EXCLUSIVE "DUAL POWER" SETTINGS

- High/Low power setting for speed and energy savings.
- 200,000/160,000 BTU's for 40 gallon models.
- 125,000/90,000 BTU's for 30 gallon models.

LOW 35" RIM HEIGHT

- Easier to safely handle food and cleaning process.

REINFORCED ROLLED RIM

- Eliminates warping of skillet pan allowing skillet cover to close properly.

SOLID STATE TEMPERATURE CONTROLS

- "Imbedded" temperature sensors for precise cooking.
- 10 tilt cooking feature.



*Cleveland gas models SGL30T1, SGL40T1.
Based on competitors spec sheets.
SEL30T1, SEL40T1 electric models.

New easyDial® Control Option

- Digital time and temperature control and indicator.
- Three cooking modes — Cook/Simmer, Cook/Off, Cook/Cook.
- Meets IPX6 water rating protection guideline.
- Six built in diagnostic indicator readouts.
- Optional core temperature probe.



EASYDIAL —
OPTIONAL CONTROLS WITH ADVANCED FEATURES FOR WORLD CLASS PERFORMANCE

Cleveland **standard controls** for tabletop kettles and T1 skillets offer simple precise, consistent solid state temperature controls with minimal temperature variance and superior cooking times.

The fully digital **easyDial®** control option is enclosed in a splashproof ergonomically angled console and offers the following key features.

ACCURATE TIME & TEMPERATURE CONTROL

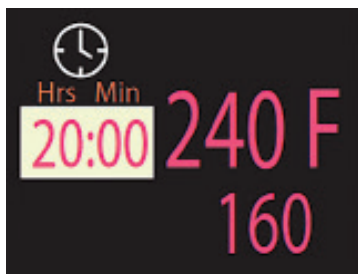

Precise temperature controls for consistent results and to help prevent overcooking and damaging the unit with burnt food.

A loud audible buzzer indicates cooking is complete.

BUILT-IN DIAGNOSTIC READOUT

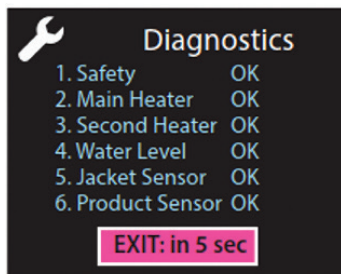

6 Built-In Self Diagnostics Indicators and Digital Readout. Simplifies troubleshooting, reduces maintenance costs and promotes first time fix.

THREE COOKING MODES

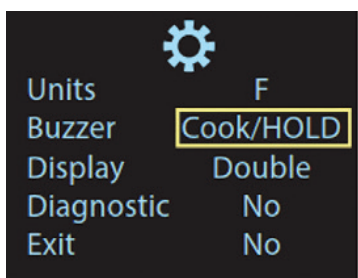

Cook/HOLD - Ideal cook and simmering applications brings food to a boil and then automatically goes into a simmering temperature. Eliminates waste due to overcooking and scorching.

Cook/ON - For cooking by time and temperature. The temperature will run continuously until manually turned off.

Cook/OFF - For cooking by time and temperature, the timer countdown turns off the heat.

CORE TEMPERATURE PROBE OPTION



Optional Core Temperature Probe can be used as an internal product probe for multiple products monitoring the core internal temperature for superior food quality.

MEETS IPX6 WATER RESISTANCE

Water related service issues are dramatically reduced.

CORRECTIONAL PACKAGES

MODEL	DESCRIPTION	LIST PRICE
FOR CLASSIC SERIES CONVECTION STEAMERS: 24", 36" AND 42" WIDE MODELS		
CP-LCBD	Tamper Proof Lockable Cabinet Base Door for 24" 36" and 42" wide Convection Steamers, and Boiler Bases. *Locks provided by others.	
CP-PR	Non-Removable-Tamper proof pan racks for interior cooking compartment for all floor model steamers.	
CP-EXT	Tamper Proof exterior compartment and cabinet base sheeting using Tamper Proof Spanner Drilled Head Screws for all floor model steamers.	
CP-SCRD	Set of Screwdrivers: For tamper proof screws.	
CP-COVER	Tamper Proof Hasp-Type* Hinged Cover for controls. *For 24" and 36" & 42" Convection Steamers only. *Locks provided by others.	
CP-CCX	TOTAL COMPLETE CORRECTIONAL PACKAGE PRICE (Includes all of the above options).	\$3,763



CP-LCBD

FOR STEAMCRAFT 3, 5, 10, GEMINI™ 6, 10 MODELS		
CP-SC10	Tamper Proof exterior with Tamper Proof Spanner Drilled Head Screws for all SteamCraft® 10 models.	
CP-SCRD	Set of Screwdrivers: For tamper proof screws.	
CP-PR	Non-Removable Tamper proof pan racks for interior cooking compartment for all floor model steamers.	
CP-PORT	Tamper Proof Hasp-Type Hinged Cover for descaling port. *Locks provided by others.	
CP-COVER	Tamper Proof Hasp-Type Hinged Cover for controls and power switch. *Locks provided by others.	
CP-SCG	TOTAL COMPLETE CORRECTIONAL PACKAGE PRICE (Includes of the above options).	\$3,804



FOR FLOOR MODEL TILTING BRAISING PANS		
CP-SCB	Tamper Proof exterior side and rear panels with Spanner Drilled Head Screws, R-Series Skilllets	
CP-SCRD	Set of three Spanner Drilled Head Screwdrivers.	
CP-PCB-T1	Protective Control Cover, T-1 Series Skilllets * Locks provided by others.	
CP-PCB-TR	Protective Control Cover, TR Series Skilllets.	
CP-TDM	Tangent Draw-Off Valve Modification.	
CP-SKTD	Correctional Package includes Tangent Draw-Off protection package CP-TDM, plus CP-SCB, CP-SCRD, CP-PCB-T1	\$2,889



CP-COVER

CORRECTIONAL PACKAGES

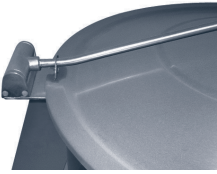

CP-CHS

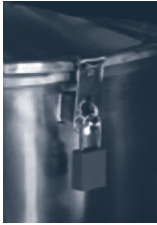

CP-HASP



CP-RB



CP-TDPB



SG



CP-PCB



SGP

MODEL	DESCRIPTION	LIST PRICE
FOR STEAM JACKETTED KETTLES: GAS, ELECTRIC AND DIRECT STEAM MODELS		
CP-CHS	Tamper Resistant Spring Assist Cover: Tamper proof screws used to prevent hinge removal. Anti rotational bracket welded to cover to prevent removal and rotation. Price does not include the cover. *Locks provided by others.	
CP-HASP	Hasp style Lockable Spring Assist Cover. * Locks provided by others	
CP-RB	Heavy Duty Reinforced Rim Bar: 1/2" X 1" stainless steel bar continuously welded around the rim.	\$3,600
CP-TDPB	Tangent Draw-Off Valve Protection: Bar type Stainless steel bar welded to kettle. Prevents operator from standing on valve.	
CP-TDM	Tangent Draw-Off Valve Modification: Selected valve will be modified by having the valve handle fastened to stem with tamper proof screws.	
CP-TD-STRAP	Cable attached to TD valve stem.	
CP-FBKT	Tamper Proof Faucet Bracket: Non removable, reinforced faucet bracket. Standard on stationary models.	
CP-SCR	Tamper Proof Screws: Standard screws replaced by tamper proof screws for fastening all removable covers and panels.	
CP-SCRD	Set of Screwdrivers: For tamper proof screws	
SG	Switch Guard: 3/16" dia. Stainless steel rod bolted over controls to prevent damage from impacts. Gas and electric models only.	
CP-PCB	Protective Box for Controls: Completely covers controls. Gas and electric models only. *Locks Provided by others.	
CP-PG	Pressure Gauge Guard: " x " stainless steel bar bolted over gauge to prevent damage from impacts. Gas and electric models only.	
SGP	Sight glass guard	
CP-STATKT	Complete correctional package for stationary kettles, options include CP-CHS tamper proof spring assist cover, CP-HASP style lockable cover, CP-TDPB Bar type tangent protection, CP TDM tamper proof TD valve, CT-TD STRAP for TD valve, CP-SCR tamper proof exterior screws and CP-SCRD set of screw drivers, SG - Bar Type Switch Guard for controls, SGCP-PCB protective control box cover, CP-PG pressure gauge guard, SGP sight glass guard. (Locks by others).	\$6,104
CP-TILTCTD	Complete correctional package Tilting Kettles WITH Tangent Draw-off option, options include CP-CHS tamper proof spring assist cover, CP-HASP style lockable cover, CP-TDPB Bar type tangent protection, CP TDM tamper proof TD valve, CT-TD STRAP, CP-SCR tamper proof exterior screws and CP-SCRD screw drivers, SG - bar type switch guard for controls, CP-FBKT tamper proof faucet bracket, SGCP-PCB protective control box cover, CP-PG pressure gauge guard, SGP sight glass guard. (Locks by others).	\$6,297
CP-TILTNT	Complete correctional package Tilting Kettles with NO Tangent Draw-OFF, options include CP-CHS tamper proof spring assist cover, CP-HASP style lockable cover, CP-SCR tamper proof exterior screws and CP-SCRD set of screw drivers, SG - bar type switch guard for controls, SGCP-PCB protective control box cover, CP-PG pressure gauge guard, SGP sight glass guard, CP-FBKT tamper proof faucet bracket (Locks by others).	\$3,704
CP-RB	Heavy Duty Reinforced Rim Bar: 1/2" X 1" stainless steel bar continuously welded around the rim.	\$3,600

Features built-in marine options designed specifically for harsh marine and shipboard conditions

- Built to comply with USPHS Vessel Sanitation Program 2018 Construction Guidelines
- Hex Style Exposed Screws with Silicon Seal.
- Anti-Corrosion Nick Chrome Plated Left Side Trunnion Assembly (Tilting Model)
- Chrome Plated Safety Valve (Kettles)
- Hex Bolt Style Stainless Steel Tangent Draw-Off Handle (optional)
- Protective Stainless Cover over controls
- Meets IPX6 Water Rating Requirements

SELF-CONTAINED ELECTRIC TABLETOP MODEL KETTLES

- 23, 45, 80 Liters (6, 12, 20 U.S. Gallons)
- Models KET6TMV, KET12TMV, KET20TMV with Marine Options
- 440-480-volt, 60 Hz. 3 Phase
- Safety Tilt Lock prevents accidental spills
- 50 PSI Steam Jacket Rating, 2/3rd Steam Jacketed



DIRECT STEAM FLOOR MODELS KETTLES

- 150, 225, 300, 380, 475, Liters (25, 40, 60, 80, 100, 125 U.S. Gallons)
- Models KDL- (40, 60, 80, 100, 125) -TMV with Marine Options
- Direct Steam, no electric required
- Self-Locking Manual Worm Gear Style Tilt, 2/3rd steam jacketed
- 50 PSI Steam Jacket Rating up to 100-gallon models, 35 PSI on 125 gallons.



SELF-CONTAINED ELECTRIC FLOOR MODELS KETTLES

- 100, 150, 225, 300, 380, Liters (25, 40, 60, 80, 100, U.S. Gallons)
- Models KEL- (40, 60, 80, 100) -TMV with Marine Options
- Electric 440-480-volt, 60 Hz. 3 Phase
- Self-Locking Manual Worm Gear Style Tilt, 2/3rd steam jacketed
- 50 PSI Steam Jacket Rating



SELF-CONTAINED ELECTRIC TILT SKILLETS (Braising Pans)

- 100, 150 Liters (30, 40 U.S. Gallons)
- Models SEL- (30, 40) -T1MV with Marine Options
- Electric 440-480-volt, 60 Hz., 3 Phase
- Self-Locking Manual Worm Gear Style Tilt



RECOMMENDED PIPE CAPACITY

The figures below are based on 100 feet of clean iron pipe, allowing 10% pressure drop. The presence of valves, elbows, etc. was not considered in calculating the values shown. If the length of pipe is less than 100 ft., the pressure drop will be proportionately less than 10%. If the rate of flow shown for a given pressure and pipe size is increased, the pressure drop will be greater. If the rate of flow is decreased, the pressure drop will be less. The pressure drops to use depends on the circumstance.

MAXIMUM FLOW RATE OF DRY STEAM IN LBS. PER HOUR

SUPPLY PRESSURE	STANDARD PIPE SIZES					
	1/2"	3/4"	1"	1-1/4"	1-1/2"	2"
5	20	40	70	140	210	380
10	30	60	110	220	320	600
15	40	80	150	290	430	
20	50	100	180	360	530	
25	60	120	220	430		
30	70	140	250	500		
35	80	160	290	570		
50	100	210	380	760		

RECOMMENDED PIPING SCHEMATIC FOR DIRECT STEAM KETTLES

KETTLES

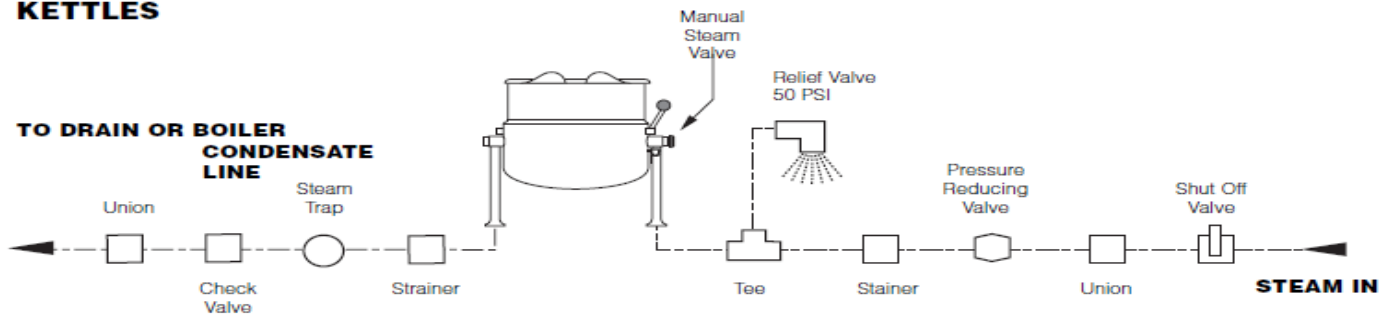

KETTLES c/w SD STANDS

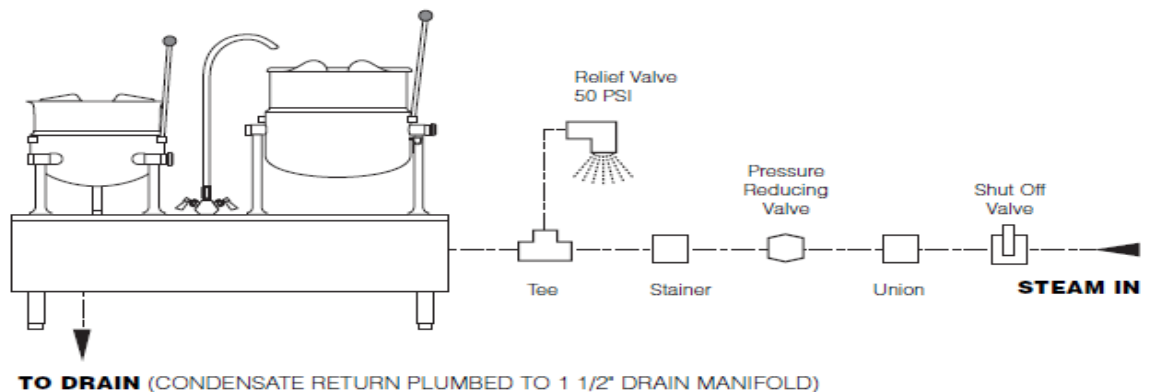

STEAM REQUIREMENT DATA, BOILER SIZING INFORMATION

Use the following information to determine the steam flow rate requirements for any combination of Cleveland kettles or any combination of Cleveland steamers and kettles.

Example: First, determine the total steam flow requirement using the charts below. Cleveland boilers operate at 8-10 PSI, a 40-gallon kettle will require 70 lbs. of steam per hour, a 2-compartment steamer will require 60 lbs. of steam per hour. Total steam required is 130 lbs. of steam per hour.

Using the Steam Flow Rate of Cleveland boilers, a 300,000 BTU generator will product 180 lbs. of steam per hour, and the 24CGP10 also produces 180 lbs. of stem per hour, enough to run both the 2-compartment steamer and 40-gallon kettle.

STEAM FLOW OF CLEVELAND BOILERS

GAS INPUT BTU PER HOUR	STEAM OUTPUT BTU (LBS. PER HOUR)	STEAM GENERATOR
200,000	125	3.6 BHP
300,000	180	5.2 BHP
ELECTRIC KW INPUT		
24	70	2.0 BHP
36	120	3.5 BHP
48	150	4.4 BHP
STEAMCRAFT POWER 10		
240,000	180	5.2 BHP

STEAM FLOW RATE REQUIREMENT FOR CLEVELAND STEAMERS (lbs. per hour, per compartment)

STEAM FLOW RATE	RATE REQUIRED AT START UP	RATE REQUIRED DURING COOKING
Convection Steamers	30	30
Pressure Steamers	30	15
ConvectionPro	75	75
SteamCraft 10 (24CGP10)	45	45

STEAM FLOW RATE REQUIREMENTS FOR CLEVELAND KETTLES

CLEVELAND KETTLES — STEAM FLOW REQUIREMENTS

KETTLE CAP.		KETTLE DIA.	8-10	240°F	15	250°F	25	267°F	40	287°F
U.S. GAL.	LITERS		PSI STEAM (LBS/HR)	STEAM (HP/HR)	PSI STEAM (LBS/HR)	STEAM (HP/HR)	PSI STEAM (LBS/HR)	STEAM (HP/HR)	PSI STEAM (LBS/HR)	STEAM (HP/HR)
5	17	12"	9	0.26	11	0.32	12.8	0.37	15.9	0.46
10	42	16"	18	0.52	21.9	0.64	25.7	0.75	32.1	0.93
20	95	21"	15	1	43.9	1.27	51.4	1.49	64.1	1.86
30	114	24"	55	1.59	65.9	1.91	77.1	2.24	96.2	2.79
40	151	26"	70	2	85.9	2.49	102.8	2.98	123.5	3.72
60	227	30"	105	3.1	131.7	3.82	154.2	4.47	192.4	5.58
80	300	33"	145	4.2	175.6	5.09	205.7	5.96	256.6	7.44
100	379	36"	175	5.1	219.5	6.36	257.1	7.45	320.7	9.3
125	473	40"	220	6.4	274	7.95	321.3	9.31	400.8	11.6
150	568	40"	250	7.25	329	9.54	385.6	11.1	481	13.9

PRESSURE/TEMPERATURE CHART

OPERATING PRESSURE (PSI)	MAX TEMPERATURE	OPERATING PRESSURE (PSI)	MAX TEMPERATURE	OPERATING PRESSURE (PSI)	MAX TEMPERATURE
0	212°	10	239°	35	281°
2	219°	15	250°	40	287°
4	224°	20	259°	45	292°
6	230°	25	267°	50	298°
8	235°	30	274°	70	316°

KETTLE AND TILT SKILLET CAPACITY SERVINGS CALCULATOR CHARTS

CLEVELAND KETTLES CAPACITY SERVING CALCULATOR

					PORTIONS: NUMBER OF SERVINGS					
KETTLE SIZE			TOTAL GALLON CAPACITY	BATCH SIZE	30 ML	60ML	90 ML	120 ML	180 ML	240 ML
GALLONS	QUARTS	LITERS			1 OZ	2 OZ	3 OZ	4 OZ	6 OZ	8 OZ
3	12	11	3.25	2.75	352	176	177	88	58	44
6	20	19	6	5	640	320	213	160	106	80
12	40	38	12	10	1,280	640	426	320	213	160
20	80	76	21	18	2,304	1,152	768	576	384	288
25	100	95	25.5	22	2,186	1,408	938	704	469	352
30	120	114	31	26	3,328	1,664	1,109	832	554	416
40	160	152	42	35	4,480	2,240	1,493	1,120	746	560
60	240	228	62	52	6,656	3,328	2,218	1,664	1,109	832
80	320	304	83	70	8,960	4,480	2,986	2,240	1,493	1,120
100	400	380	103	85	10,880	5,440	3,626	2,720	1,813	1,360
125	500	475	129	105	13,440	6,720	4,480	3,360	2,240	1,680
150	600	570	155	125	16,000	8,000	5,333	4,000	2,666	2,000

TILT SKILLET CAPACITY SERVING CALCULATOR

					PORTIONS: NUMBER OF SERVINGS					
TILT SKILLET SIZE			TOTAL GALLON CAPACITY	BATCH SIZE	30 ML	60ML	90 ML	120 ML	180 ML	240 ML
GALLONS	QUARTS	LITERS			1 OZ	2 OZ	3 OZ	4 OZ	6 OZ	8 OZ
10	40	38	10	10	1,280	640	426	320	213	160
15	60	60	15	15	1,920	960	639	480	320	240
30	120	114	31	26	3,328	1,664	1,109	832	554	416
40	160	152	42	35	4,480	2,240	1,493	1,120	746	560

ENERGY STAR STEAMER DATA

Use the Information below for energy and water consumption information on Cleveland Energy Star Steamers and LEED requirement information

MODEL NUMBER	22CCT6	22CET3.1	22CET6.1	22CGT3.1	22CGT6.1	24CGA10.2ES
Pan Capacity	6	3	6	3	6	10
Primary Fuel Source	ELECTRIC	ELECTRIC	ELECTRIC	GAS	GAS	GAS
Type	BOILERLESS	BOILERLESS	BOILERLESS	BOILERLESS	BOILERLESS	GENERATOR
Cooking Energy Efficiency (%)	70%	67%	64%	39%	43%	45%
Water Consumption (Gal/Hr)	3.6	2.3	1.5	2.17	1.7	15.6
Water Consumption (Gal/Hr) — Per Pan	0.6	.076	.25	0.72	0.28	1.56
Idle Energy Rate (Watts)	670	180	490			
Idle Energy Rate (BTU/Hr)				2440	3640	3894

LEED REQUIREMENTS

LEED REQUIREMENTS 4.1	BD+C (Healthcare, Retail, Schools, Hospitality)	BD+C (Commercial Kitchens, At Least 100 Meals/Day)
(WE) Water Efficiency Credit		
Food Steamer — Batch Cooking	≤ 6 gal/Hr/Pan	
Food Steamer — Cook to Order	≤ 10 gal/Hr/Pan	
LEED REQUIREMENTS 4.1		
Food Steamer — Batch Cooking, No Drain	≤ 6 gal/Hr/Pan	
Food Steamer — Cook to Order, With Drain	≤ 10 gal/Hr/Pan	
*Includes drain condensing water		
(EA) Energy Performance Credit		
	Must Meet Energy Star	Must Meet Energy Star

STATEMENT OF POLICY

Cleveland Steam Cooking Equipment is intended for Commercial use only by professionally trained personnel.

Cleveland Steam Cooking Equipment is built to comply with applicable standards of manufacturers. Included among these approval agencies are: U.L., N.S.F., A.S.M.E./Ntl. Bd., C.S.A., A.G.A., C.G.A., E.T.L., C.E., and others. Many local codes exist, and it is the responsibility of the Owner and Installer to comply with these codes. Constant product improvement makes it necessary for new or improved models to be suited for testing by these various agencies. Therefore, not all models may always have all agency approvals. Cleveland Steam Boilers (Steam Generators) and Kettles are National Board registered and carry the approved stampings and listing of the American Society of Mechanical Engineers (A.S.M.E.). Cleveland Steam Cooking Equipment, when properly installed according to instructions, complies with the intent of the O.S.H.A. Act.

SALES POLICY

All orders must have the Dealer's name and address; shipping address; and installation location, including name, address and phone number before the order can be processed.

All orders should indicate model number, electrical characteristics, type of gas, altitude (if installation is over 2000 feet) and, when required, the incoming steam pressure.

Approved drawings, when required, and firm shipping date must be received before equipment can be scheduled for production.

Specify left or right door hinging for cooking compartments on Convection and SteamCraft® Steamers.

RETURN POLICY

- 1 | All returned product must have an RMA number from Customer Service prior to sending the product back.
- 2 | The product must be standard product, still in original packaging and within 90 days from date invoiced. Standard products are defined as product configurations that are saleable to the general market. Custom Products are product configurations that are unique to a specific customer and cannot be sold to other customers. Obsolete discontinued products cannot be returned.
- 3 | If return is approved for standard product, the standard restock charge is 30% or 20% if a replacement order is made.
- 4 | Custom product is non-returnable.
- 5 | Applicable freight charges and re-crating will be the customer's responsibility.
- 6 | RMA number must be clearly written on all shipping paperwork to factory/warehouse.
- 7 | RMA will be valid for 45 days from date of issue.

TERMS AND CONDITIONS (START UP COOK CHILL)

TECHNICAL STARTUP

- 1 DAY TECHNICAL START UP AND EQUIPMENT CALIBRATION (\$1,500 NET PRICE PER DAY CONTINENTAL U.S.A)

OPERATIONAL STARTUP

- 1 DAY OPERATIONAL START UP AND EQUIPMENT CALIBRATION (\$1,500 NET PRICE PER DAY CONTINENTAL U.S.A)

TERMS & CONDITIONS

THIS QUOTATION IS SUBJECT TO THE FOLLOWING CONDITIONS

ALL PRICES ARE DEALER NET, FOB FACTORY AS LISTED ABOVE

ORDER PLACEMENT WITHIN 90 DAYS FROM DATE OF THIS QUOTATION LEADTIMES APPROXIMATELY 23 -25 WEEKS, FINAL LEAD TIMES CAN ONLY BE DETERMINED AFTER PURCHASE ORDER HAS BEEN RECEIVED AND ACKNOWLEDGED AND BASED ON FACTORY LOAD, ORDER SIZE, SPECIAL ELECTRICAL CHARACTERISTICS AND APPROVED SIGNED FACTORY DRAWINGS

PRODUCT LINE

ALL DIRECT STEAM HORIZONTAL AND VERTICAL MIXER KETTLES 40% UPFRONT DEPOSIT, BALANCE NET 30 DAYS

TURBOJET WATER BATH, BLAST CHILLERS & CONDENSING UNITS 40% UPFRONT DEPOSIT, BALANCE NET 30 DAYS

ALL GAS & ELECTRIC HORIZONTAL AND VERTICAL MIXER KETTLES NET 30 DAYS

MFS SERIES FOOD PUMP/CLIPPERS/VACUUM SEALERS NET 30 DAYS

COOK CHILL ACCESSORIES AND AIR COMPRESSORS NET 30 DAYS

NOTE

HE ABOVE COOK CHILL PRICING IS DEALER NET AND DOES NOT QUALIFY FOR ANY DEALR REBATES OF BUYING GROUP PROGRAMS

PRESSURE BOILER AND STEAM GENERATOR MAINTENANCE IS THE RESPONSIBILITY OF THE OWNER-USER AND IS NOT COVERED BY THIS WARRANTY. The use of good quality feed water is the responsibility of the Owner-User (see Water Quality Recommendations below). THE USE OF POOR QUALITY FEED WATER WILL VOID EQUIPMENT WARRANTIES. Boiler maintenance supplies, including boiler hand gaskets, are not warranted beyond the first 90 days after the date the equipment is placed into service. Preventive maintenance records must be available showing descaling per applicable Cleveland Operator Manual for Boiler

CLEVELAND RANGE — LIMITED WARRANTY

CLEVELAND RANGE products are warranted to the original purchaser to be free from defects in materials and workmanship under normal use and service for the standard warranty period of one year from date of installation or 18 months from date of shipment, whichever comes first.

CLEVELAND RANGE agrees to repair or replace, at its option, f.o.b. factory, any part which proves to be defective due to defects in material or workmanship during the warranty period, providing the equipment has been unaltered, and has been PROPERLY INSTALLED, MAINTAINED, AND OPERATED IN ACCORDANCE WITH THE CLEVELAND OWNER'S MANUAL.

CLEVELAND RANGE agrees to pay any FACTORY AUTHORIZED SERVICE (FAS) AGENCY (within the continental United States, and Hawaii) for reasonable labor required to repair or replace, at our option, f.o.b. factory, any part which proves to be defective due to defects in material or workmanship, during the labor warranty period. This warranty includes travel time not to exceed two hours and mileage not to exceed 50 miles (100 miles round-trip), BUT DOES NOT INCLUDE POST START-UP, TIGHTING LOOSE FITTINGS, MAINTENANCE, CLEANING OR DESCALING.

The standard labor warranty allows factory payment of reasonable labor required to repair or replace such defective parts. CLEVELAND RANGE will not reimburse the expense of labor required for the repair or replacement of parts after the standard warranty period, unless an Extended Labor Warranty Contract has been purchased to cover the equipment for the balance of the warranty period from the date of equipment installation, start-up, or demonstration.

PROPER INSTALLATION IS THE RESPONSIBILITY OF THE DEALER, THE OWNER-USER, OR INSTALLING CONTRACTOR, AND IS NOT COVERED BY THIS WARRANTY. Many local codes exist, and it is the responsibility of the owner and installer to comply with these codes. CLEVELAND equipment is built to comply with applicable standards for manufacturers, including UL, AGA, NSF, ASNE/Ntl. Bd, CSA, CGA, ETL and others.

PRESSURE BOILER AND STEAM GENERATOR MAINTENANCE IS THE RESPONSIBILITY OF THE OWNER-USER AND IS NOT COVERED BY THIS WARRANTY. The use of good quality feed water is the responsibility of the Owner-User (see Water Quality Recommendations below). THE USE OF POOR QUALITY FEED WATER WILL VOID EQUIPMENT WARRANTIES. Boiler maintenance supplies, including boiler hand gaskets, are not warranted beyond the first 90 days after the date the equipment is placed into service. Preventive maintenance records must be available showing descaling per applicable Cleveland Operator Manual for Boiler Proration Program considerations.

WATER QUALITY RECOMMENDATIONS			
Total Dissolved Solids (TDS)	50 - 250 ppm	SiO42 (Sulfate)	max 150 ppm
Hardness	50 - 200 ppm (3-12 gpg)	NH2Cl (Monochloramine)	max .01 ppm
pH value	7.0 - 8.5	Total Alkalinity	50 - 100 ppm
CL (Chloride)	max 50 ppm	Water Pressure	35 - 80 PSI
Cl2 (free chlorine)	max 0.1 ppm	Water Temperature	max 104°F

The foregoing shall constitute the sole and exclusive remedy of original purchaser and the full liability of Cleveland Range for any breach of warranty. THE FOREGOING IS EXCLUSIVE AND IN LIEU OF ALL OTHER WARRANTIES, WHETHER WRITTEN, ORAL, OR IMPLIED, INCLUDING ANY WARRANTY OF PERFORMANCE, MERCHANTABILITY, OR FITNESS FOR PURPOSE, AND SUPERSEDES AND EXCLUDES ANY ORAL WARRANTIES OR REPRESENTATIONS, OR WRITTEN WARRANTIES OR REPRESENTATIONS, NOT EXPRESSLY DESIGNATED IN WRITING AS A "WARRANTY" OR "GUARANTEE" OF CLEVELAND RANGE MADE OR IMPLIED IN ANY MANUAL, LITERATURE, ADVERTISING BROCHURE OR OTHER MATERIALS.

CLEVELAND RANGE'S liability on any claim of any kind, including negligence, with respect to the goods or services covered hereunder, shall in no case exceed the price of the goods or services, or part thereof, which gives rise to the claim. IN NO EVENT SHALL CLEVELAND RANGE BE LIABLE FOR SPECIAL, INCIDENTAL, OR CONSEQUENTIAL DAMAGES, OR ANY DAMAGES IN THE NATURE OF PENALTIES.

CLEVELAND RANGE — LIMITED WARRANTY (CONT.)

PRESSURE BOILER — STEAM GENERATOR WARRANTY

All Pressure boilers and steam generators will receive an additional 4 year prorated limited parts warranty after one year from effective warranty date. The user shall pay a prorated share of the selling price based on number of months in service. Prorated Coverage: 1 Year 100% - 2 Year 80% (100% with purchase of filter) - 3 Year 60% - 4 Year 40% - 5 year 20%.

PERFORMANCE START UP & DEMONSTRATION

Performance Start up by Factory Authorized Servicer included at customer request after equipment is installed to ensure equipment is installed properly and performing as designed. Included in the startup is a Free Water Quality Check (Contact Cleveland sales representative for details).

THREE YEAR WARRANTY K-12 SCHOOL WARRANTY

For K-12 Schools, extended two-year limited warranty at no additional charge, not to exceed 24 months from date of installation. 3rd Year Water Filter Warranty included, see details below.

3-YEAR STEAMER DOOR WARRANTY, DOOR GASKETS AND ADJUSTMENTS

3-year limited parts warranty on 3, 5, 6 compartment steamer doors (Gaskets covered under 1-year limited warranty). Non part replacement adjustments on steamers, kettles and tilt skillets (lose wires, clamps, leaks) covered under 1-year limited warranty.

EXTENDED WATER FILTER WARRANTY

When purchasing a steamer and Cleveland specified water filter from Cleveland Ranged at the same time, a second year limited extended warranty on will be included at no charge, must include a completed Performance Start-Up and water quality check. Must maintain equipment and filter replacements.

EXTENDED WARRANTY

The purchase of a Limited Extended Warranty Contract extends the standard warranty coverage to the purchased period demonstration, or 18 months from date of shipment, whichever comes first. Individual warranties may vary by model, part or application. Major components have labor extended an additional year with the purchase of an extended warranty, but not parts. Extended warranties are non-transferable. Only available in the 48 contiguous US states (Hawaii and Alaska are excluded).

- Performance Start up required for extended warranty coverage.
- Extended Warranty must be purchased at the same time the equipment is purchased.
- Extended Warranty has the same exclusions as stated in our standard warranty.

PRICES FOR EXTENDED WARRANTY ARE NET PRICES

- 10% off net prices when purchased with Welbilt Kitchencare Installation
- 20% off net prices when purchased with Welbilt Kitchen Preventative Maintenance (PM) Program
- 30% off net prices when purchased with Welbilt Kitchencare Installation and PM Program

PRODUCT	PART NUMBER	ITEM DESCRIPTION
SteamChef	EW Steamchef	+1YR Warranty Steamchef
SteamCraft 3	EW SCraft 3.1	+1YR Warranty Steamcraft31
SteamCraft 5	EW SCraft 5.1	+1YR Warranty Steamcraft51
SteamCraft 10	EW Steam 10	+1YR Warranty Steam10 Pan
ALL KETTLES	EW Kettle	+1YR Warranty Kettle
ALL TILT KETTLES	EW Skillet	+1YR Warranty Skillet

STEAMERS — CLEVELAND CERTIFIED INSTALLATION PROGRAM AND KITS

Cleveland's Factory Authorized Servicer (FAS) will arrange and oversee the complete installation and start-up process to ensure proper operation. Installation and Installation Kits are net prices – non discountable.

STANDARD INSTALLATION PRICING INCLUDES

- Travel to and from installation location by Factory Authorized Servicer (FAS) up to 100 miles round trip, (additional charge for sites over 100 miles round trip)
- Professionally reviewed and managed install process
- Delivery of purchased equipment
- Uncrating of purchased equipment
- Inspection of purchased equipment prior to install
- Assembly of purchased equipment
- Stacking of purchased equipment
- Placement of unit
- Leveling of unit
- Connection of existing utilities within 3 feet of unit
- Operational/functional test
- Disposal of new equipment packaging and dunnag
- Operator functional training on day of installation
- Equipment startup

STANDARD INSTALLATION PRICING DOES NOT INCLUDE

- Pre-installation site survey (required)
- Installation kit (recommended)
- Installation of water filtration, additional charges as shown below
- Special licensing and permits
- Installation at "secure" location (such as prisons) can be quoted
- Installation outside normal business hours
- Site modifications
- Some installation locations will require additional materials to be purchased by customer
- In the event the pre-installation site survey or installation visit is aborted due to the site not being ready, the customer will be required to pay the FAS directly for any additional labor and travel charges for subsequent visits.
- Disposal of old equipment, additional charge as shown below.

AVAILABLE CLEVELAND INSTALLATION PROGRAMS

MODEL	DESCRIPTION	NET PRICE
INSTALLATION OF FIRST UNIT		
11000115896	Table Top Steamers: 22CET3/6.1, 22CGT3/6.1, 21CET8, 21CET16, 21CGA5	\$1,815
11000115898	Floor Model Steamers: 24CGA10, 24CEA10, 24CGA10.2, 24CGA6.2S	\$2,625
11000115900	Floor Model Steamer: 24CGP10	\$3,652
INSTALLATION OF SECOND UNIT		
11000115897	Table Top Steamers: 22CET3/6.1, 22CGT3/6.1, 21CET8, 21CET16, 21CGA5	\$981
11000115899	Floor Model Steamers: 24CGA10, 24CEA10, 24CGA10.2, 24CGA6.2S	\$1,851
11000115901	Floor Model Steamer: 24CGP10	\$3,086
ADDITIONAL INSTALLATION PROGRAM SERVICES		
11000116000	Pre Installation Site Survey (Required)	\$311
11000116001	Water Filter Installation - Standard System, Only Filters Include Models In Price List	\$274
11000116003	Disposal Of Old Equipment	\$392
INSTALLATION KITS		
INSTKITCET1	Installation Kit, Electric Steamers 22CET3/6, 21CET8, 208-240 Volt Series	\$1,201
INSTKITCET2	Installation Kit, Electric Steamers 22CET3/6, 21CET8/16, 480 Volt Series	\$1,054
INSTKITCET3	Installation Kit, Electric Steamers 21CET16, 208, 220, 240 Volt Series	\$1,078
INSTKITCET4	Installation Kit, Electric Steamers 24CEA10 208, 240, 480 Volt Series	\$1,391
INSTKITCGA5	Installation Kit, Gas Steamers 21CGA5, 22CGT3/6 Series	\$1,376
INSTKITCGA6	Installation Kit, Gas Steamers 24CGA, 24CGP Series	\$1,516
INSTKITCGA7	Installation Kit, 24CGA10.2ES	\$1,516

INSTALLATION PROGRAM- KETTLES & SKILLETS

MODEL	DESCRIPTION	NET PRICE
INSTALLATION OF FIRST UNIT		
11000115896	Tabletop kettles: KET3T, KET6T, KET12T, KGT6T, KGT12T, TKET3T, TKET6T, TKET12T, Tabletop skillets SET10, SET15, includes water faucet installation purchased from Cleveland	\$1,815
11000115902	Floor model Gas & Electric kettles KEL, KGL series, Tilt Skillets SEL, SGL TR-T1 series, includes water faucet installation purchased from Cleveland	\$2,400
INSTALLATION OF SECOND UNIT		
11000115897	Tabletop kettles: KET3T, KET6T, KET12T, KGT6T, KGT12T, TKET3T, TKET6T, TKET12T, Tabletop skillets SET10, SET15, includes water faucet installation purchased from Cleveland	\$981
11000115903	Floor model Gas & Electric kettles KEL, KGL series, Tilt Skillets SEL, SGL TR-T1 series	\$1,200
ADDITIONAL INSTALLATION PROGRAM SERVICES		
11000116000	Pre Installation Site Survey (Required)	\$311
11000116002	Disposal Of Old Equipment	\$392
INSTALLATION KITS- GAS MODEL KETTLES AND TILT SKILLETS		
INSTKGTLP	¾" Quick disconnect for all gas kettles and tilt skillets include ¾" gas line and quick disconnect Hose, ¾" street elbow, cable with mounting bracket	\$276
INSTKEL25APLG	for 25 AMP operation, 12 AWG x 8' long wire, 10-30P Plug	\$138
INSTKEL35APLG	for 35 AMP operation, 8 AWG x 8' long wire, 15-50P Plug	\$219
INSTKEL45APLG	for 45 AMP operation, 6 AWG x 8' long wire, 15-50P plug	\$255
INSTKEL60APLG	for 60 AMP operation, 4 AWG x 8' long wire, 15-60P Plug	\$358
INSTKEL80APHW	for 80 AMP operation, 2 AWG x 8' long wire, hard wire	\$774
INSTKEL100APHW	for 100 AMP operation, 2 AWG x 8' long wire, hard wire, includes Arlington 8413 Metal Cable Connector	\$774
INSTWATER	Install kit for optional water faucets, two ¾"- 6' long water hoses, 1/2" NPT Male x ¾" garden hose male	\$78

WATER TREATMENT SELECTION GUIDE

1 UNDERSTAND THE BASIC WATER CHARACTERISTICS OF YOUR WATER

Compare water quality at your location to the Cleveland Water Quality Requirements listed here.

- Contact your water company for information about the quality of your water.
- Cleveland can provide a complete water analysis through an independent laboratory

CLEVELAND WATER QUALITY RECOMMENDATIONS			
Total Dissolved Solids (TDS)	50 - 250 ppm	Cl ₂ (Free Chlorine)	max .01 ppm
Hardness	50 - 200 ppm (3-12 gpg)	Fe (Iron)	max .01 ppm
pH value	7.0 - 8.5	SiO ₂ (Silica)	max 13 ppm
CL (Chloride)	max 50 ppm	NH ₂ Cl (Monochloramine)	max .01 ppm

2 SELECTING THE RIGHT SYSTEM FOR YOUR EQUIPMENT

Determine if your water meets or does not meet Cleveland water quality requirements and select the right system for your applications.

CLEVELAND STEAMER MODEL	WATER QUALITY		
	MEETS STANDARD		DOES NOT MEET STANDARD
	ALL APPLICATIONS	HARDNESS ABOVE 170 ppm, pH is below 8.5 pH.	ALL APPLICATIONS
STEAMCHEF SERIES (BOILERLESS)			
22CET3.1, (6.1), 22CGT3.1 (6.1) STEAMCRAFT (GENERATORS)	FLT0040	FLT0043	Call for Options
21CET8	FLT0040	FLT0043	Call for Options
21CET16	FLT0040	FLT0043	Call for Options
21CGA5	FLT0040	FLT0043	Call for Options
6-10 PAN MODELS (GENERATORS)			
24CGA6.2S	FLT0040	FLT0043	Call for Options
24CGA10.2ES (Energy Star)	FLT0040	FLT0043	Call for Options
24CGA10	FLT0040	FLT0043	Call for Options
24CGA10.2	FLT0040	FLT0043	Call for Options
24CEA10	FLT0040	FLT0043	Call for Options
24CGP10	FLT0040	FLT0043	Call for Options
CLASSIC CONVECTION SERIES (BOILER)			
200,000 BTU Boilers (24CGM200)	FLT0040	FLT0043	Call for Options
300,000 BTU Boilers (36CGM300)	FLT0040	FLT0043	Call for Options
24 kW Boilers (24CEM)	FLT0040	FLT0043	Call for Options
36 kW, 48 kW Boilers (24CEM)	FLT0040	FLT0043	Call for Options
24 kW Boilers PEM24	FLT0040	FLT0043	Call for Options
36 kW Boilers PEM36	FLT0040	FLT0043	Call for Options
48 kW Boilers PEM48	FLT0040	FLT0043	Call for Options

Optipure OP Series systems utilize reverse osmosis (RO) to remove total dissolved solids (TDS) from water, including chlorides and hardness mineral. Then balance of minerals is introduced into the pure water to provide desirable "Optimized" water with a stable, non-aggressive nature that can significantly reduce water-related equipment problems including corrosion and scale.

Optipure FLT0040 recommended for Cleveland steamers with steam generators reduces chlorine/ chloramines and takes out sediment down to micro and includes IsoNet™ scale inhibitor.

Optipure QFLT0043 recommended for use with steam generators, reduces chlorine and takes out sediment down to micron. ScaleX2 uses "template assisted crystallization" to effectively minimize scale formation at high.

WATER QUALITY TEST KIT
PART NO: 1150360

CLEVELAND RANGE QUICKSHIP

PRODUCT SERIES	ITEM #	MODEL NUMBER — DESCRIPTION	SHIP WT LBS/KGS
STEAMERS			
	22CCT62082403CEZT	Model 22CCT6 — Steamchef, 6-Pan Boilerless, Connectionless Steamer, 208-240 Volt, 3 Phase, With Cord & Plug	335/153
	22CET32082403EZT	Model 22CET3.1 — Steamchef, 3-Pan Boilerless Steamer, 208-240 Volt, 3 Phase, easyTimer Control	235/107
	22CET62082403EZT	Model 22CET6.1 — Steamchef, 6-Pan Boilerless Steamer, 208-240 Volt, 3 Phase, easyTimer Controls	335/153
	22CGT6.1NATEZT	Model 22CGT6.1 — Steamchef 6 -Pan Boilerless Steamers, Natural Gas, 120 Volt, easyTimer Controls	355/161
	21CET82083EZT	Model 21CET8 — Steamcraft 3, 3-Pan Steamer, Electric Generator, 208 Volt, 3 Phase	210/50
	24CGA10NEZT	Model 21CGA10 — Steamcraft, 10-Pan Gas Steamer, Natural Gas With Generator, 120 Volt, easyTimer Control	565/256
	24CEA10.24803EZT	Model 21CEA10 — Gemini, 10-Pan Gas Steamer, Natural Gas, With Electric Generator, 480 Volt, 3 Phase, easyTimer Control	528/240
	24CGA10.2NEZT	Model 21CGA10.2 — Gemini Series , 10-Pan Gas Steamer, Natural Gas, With Generator, 120 Volt, easyTimer Control	565/256
	24CEA10.22083EZT	Model 24CEA10.2— Gemini Series, 10-Pan Convection, Electric Gemini Series Twin Generator, 16 Kw Each	528/240
	KETTLES		
	KET6TP	Model KET6T — 6 Gallon Electric Kettle, 208-240 Volt, 3 Phase, Field Adjustable To Single Phase	160/73
	KET12TP	Model KET12T - 12 Gallon Electric Kettle, 208-240 Volt, 3 Phase, Field Adjustable To Single Phase	180/82
	KGT12TP	Model KGT12T — 12 Gallon Gas Kettle, Natural Gas, 120 Volt With Cord And Plug	190/86
	KGL40P	Model KGL40 — 40 Gallon Stationary Gas Fired Kettle, Natural Gas, 120 Volt, Cord & Plug, 2" Tangent Draw-Off, Spring Assist Cover	520/235
	KGL40TP	Model KGL40T — 40 Gallon Tilting Gas Fired Kettle, Natural Gas, 120 Volt, Cord & Plug, 2" Tangent Draw-Off, Spring Assist Cover, Manual Hand Tilt	520/235
KEL40TP	Model KEL40T— 40 (150 Liter) Gallon Electric Tilting With Standard Controls, Electric, Tilting	360/163	
TILT SKILLETS			
	SGL30T1NATHTP	Model SGL30T1, 30 Gallon Gas Fired Tilt Skillet, Natural Gas, 120 Volt, With Cord & Plug	520/237
	SGL40T1NATHTP	Model SGL40T1, 40 Gallon Gas Fired Tilt Skillet, Natural Gas, 120 Volt, With Cord & Plug	610/277
	SGL30TNATHTP	Model SGL30TR, 30 Gallon Gas Fired Tilt Skillet, Natural Gas, 120 Volt, With Cord & Plug	498/227
	SGL40TNATHTP	Model SGL40TR, 40 Gallon Gas Fired Tilt Skillet, Natural Gas, 120 Volt, With Cord & Plug	528/240
	SGL40TNATHTD2P	Model SGL40TR— 40 Gallon (156 Liter) Gas Manual Tilt - Open Base	622/318
	SGL30T1NATHTTD2P	Model SGL30T1— 30 Gallon (117 Liter) Gas Manual Tilt	520/237
	SGL40T1NATHTTD2P	Model SGL40T1— 40 Gallon (156 Liter) Gas Manual Tilt	610/277

SHIPPING WEIGHTS, DIMENSIONS, CUBIC FEET, FREIGHT CLASS

MODEL NUMBER	PRODUCT LINE	WEIGHT (LBS)	LENGTH (IN)	WIDTH (IN)	HEIGHT (IN)	CUBIC FEET	FREIGHT CLASS
SD1050K66	Kettle, Direct Steam	302	45	44	55	12	85
SD450K6	Kettle, Direct Steam	145	45	44	55	12	85
SD650K12	Kettle, Direct Steam	240	45	44	55	12	85
SD760K12	Kettle, Direct Steam	320	45	44	55	12	85
SD760K20	Kettle, Direct Steam	330	45	44	55	12	85
TKET12T	Kettle, Electric	304	28	54	39	10.1	85
TKET3T	Kettle, Electric	135	28	54	39	10.1	85
TKET6T	Kettle, Electric	220	28	54	39	10.1	85
24EMK6	Kettle, Electric	403	30	43	67	11.7	85
KDL25T	Kettle, Direct Steam	170	38	38	54	10.8	85
KDL25T	Kettle, Direct Steam	285	38	38	54	10.8	85
KDL40	Kettle, Direct Steam	241	44	44	54	11.8	85
KDL40T	Kettle, Direct Steam	291	44	44	54	11.8	85
KDL60	Kettle, Direct Steam	279	48	48	54	12.5	85
KDL60T	Kettle, Direct Steam	364	48	48	54	12.5	85
KDM40T	Kettle, Direct Steam	377	44	44	54	11.8	85
KDM60T	Kettle, Direct Steam	430	44	44	54	11.8	85
KDT10T	Kettle, Direct Steam	50	23	26	27	6.3	85
KDT12T	Kettle, Direct Steam	74	23	26	27	6.3	85
KDT1T	Kettle, Direct Steam	20	16	16	14	3.8	85
KDT20T	Kettle, Direct Steam	90	24	24	24	91	85
KDT3T	Kettle, Direct Steam	34	23	26	17	5.5	85
KDT6T	Kettle, Direct Steam	40	23	26	27	6.3	85
KEL100	Kettle, Electric	467	48	48	54	12.5	85
KEL25	Kettle, Electric	240	38	38	54	10.8	85
KEL25T	Kettle, Electric	304	39	39	54	11	85
KEL30	Kettle, Electric	282	38	38	55	10.9	85
KEL40	Kettle, Electric	296	38	38	55	10.9	85
KEL40SH	Kettle, Electric	280	44	44	54	11.8	85
KEL40T	Kettle, Electric	365	44	44	54	11.8	85
KEL40T	Kettle, Electric	455	44	44	54	11.8	85
KEL60	Kettle, Electric	380	48	48	54	12.5	85
KEL60T	Kettle, Electric	471	48	48	54	12.5	85
KEL80	Kettle, Electric	411	48	48	54	12.5	85
KEL80T	Kettle, Electric	470	54	54	54	12.5	85
KET12T	Kettle, Electric	177	28	38	39	8.8	85
KET20T	Kettle, Electric	273	38	38	54	10.8	85
KET3T	Kettle, Electric	123	28	39	39	8.8	85
KET6T	Kettle, Electric	134	28	38	39	8.8	85
KGL25	Kettle, Gas	384	38	38	54	10.8	85
KGL25T	Kettle, Gas	462	38	38	54	10.8	85
KGL40	Kettle, Gas	454	44	44	54	11.8	85
KGL40SH	Kettle, Gas	552	49	49	54	12.7	85
KGL40T	Kettle, Gas	552	49	49	54	12.7	85
KGL60	Kettle, Gas	510	44	44	54	11.8	85
KGL60T	Kettle, Gas	645	44	44	59	12.3	85

SHIPPING WEIGHTS, DIMENSIONS, CUBIC FEET, FREIGHT CLASS

MODEL NUMBER	PRODUCT LINE	WEIGHT (LBS)	LENGTH (IN)	WIDTH (IN)	HEIGHT (IN)	CUBIC FEET	FREIGHT CLASS
KGL80	Kettle, Gas	597	56	55	59	14.2	85
KGT12T	Kettle, Gas	271	38	38	54	10.8	85
KGT6T	Kettle, Gas	198	28	38	39	8.8	85
21CET16	Steamer, Electric	248	30	35	36	8.4	85
21CET8	Steamer, Electric	181	30	35	30	7.9	85
21CGA5	Steamer, Electric	260	31	41	37	9.1	85
22CET3.1	Steamer, Electric	238	30	40	36	8.8	85
22CET6.1	Steamer, Electric	282	30	41	40	9.3	85
22CGT6.1	Steamer, Gas	341	30	41	36	8.9	85
24CDP10	Steamer, Direct Steam	470	49	41	78	14	85
24CEA10	Steamer, Electric	528	49	41	78	14	85
24CEM24	Steamer, Electric	530	30	43	68	11.8	85
24CGA10.2	Steamer, Gas	565	49	41	78	14	85
24CGA10	Steamer, Gas	565	49	41	78	14	85
24CGA6.2	Steamer, Gas	565	49	41	78	14	85
24CGM200	Steamer, Gas	610	30	43	68	11.8	85
24CGP10	Steamer, Gas	830	49	41	78	14	85
24CSM	Steamer, Steam Coil	635	30	43	68	11.8	85
36CEM1648	Steamer, Electric	1080	44	42	80	13.8	85
36CGM300	Steamer, Electric	755	44	42	80	13.8	85
24GM	Boiler Base, Gas	454	30	43	67	11.7	85
36GM	Boiler Base, Gas	610	30	43	67	11.7	85
PDL2	Pressure Steamer	510	44	42	80	13.8	85
PDL3	Pressure Steamer	600	44	42	80	13.8	85
PDL4	Pressure Steamer	620	44	42	80	13.8	85
PEM242	Pressure Steamer	830	44	42	80	13.8	85
PEM243	Pressure Steamer	875	44	42	80	13.8	85
PGM2002	Pressure Steamer	874	44	42	80	13.8	85
PGM3003	Pressure Steamer	1040	44	42	80	13.8	85
SEL30T1	Tilt Skillet, Electric	565	44	44	54	11.8	100
SEL30TR	Tilt Skillet, Electric	503	44	44	55	11.9	100
SEL40T1	Tilt Skillet, Electric	610	48	58	54	13.3	100
SEL40TR	Tilt Skillet, Electric	610	48	58	54	13.3	100
SET10	Tilt Skillet, Electric	212	34	34	34	8.5	100
SET15	Tilt Skillet, Electric	195	34	34	34	8.5	100
SGL30T1	Tilt Skillet, Gas	500	44	44	54	11.8	100
SGL30TR	Tilt Skillet, Gas	504	44	44	54	11.8	100
SGL40T1	Tilt Skillet, Gas	666	48	58	55	13.4	100
SGL40TR	Tilt Skillet, Gas	624	48	58	54	13.3	100

COOK CHILL AND SPECIALIZED EQUIPMENT



MIXER KETTLES, DIRECT STEAM, VERTICAL SWEEP & FOLD SERIES

STEAM JACKETED MIXER KETTLES

Cleveland Floor Model Direct Steam Mixer Kettles, 3" Butterfly Valve With Acme Thread. Built In Two Piece Hinged Cover With Built In Safety Screen, 50 PSI Steam Jacket Rating, Variable Speed Agitator With 0-70 RPM Scraper Blade, 0-210 RPM Secondary Agitator, 208-240 Volt - 3/4 Horse Power Belt Drive, Gallon or Liter Markings On Mixer Shaft (10 Gallon/40 Liter Increments), DPK Double Pantry Faucet, Manual Hand Tilt, 316 Stainless Steel Liner, Certified to Applicable UL, CSA and NSF Standards, CE Certification



PRODUCT SERIES	MODEL	DESCRIPTION	SHIP WT LBS/KGS
	MKDL40T	40 Gallon (150 Liter) Floor Model Direct Steam Mixer Kettle Hand Tilt Std	700/315
	MKDL60T	60 Gallon (225 Liter) Floor Model Direct Steam Mixer Kettle Hand Tilt Std	740/333
	MKDL80T	80 Gallon (300 Liter) Floor Model Direct Steam Mixer Kettle Hand Tilt Std	830/373
	MKDL100T	100 Gallon (375 Liter) Floor Model Direct Steam Mixer Kettle Hand Tilt Std	910/409
	MKDL125T	125 Gallon (475 Liter) Floor Model Direct Steam Mixer Kettle Hand Tilt Std	1000/450
	MKDL150T	150 Gallon (575 Liter) Floor Model Direct Steam Mixer Kettle Power Tilt Std	1100/495
	TMKDL40T	Twin 40 Gallon (150 Liter Ea) Floor Model Direct Steam Mixer Kettle Hand Tilt Std	1360/612
	TMKDL60T	Twin 60 Gallon (225 Liter Ea) Floor Model Direct Steam Mixer Kettle Hand Tilt Std	1610/730
	TMKDL80T	Twin 80 Gallon (300 Liter Ea) Floor Model Direct Steam Mixer Kettle Hand Tilt Std	1700/771
	TMKDL100T	Twin 100 Gallon (375 Liter Ea) Floor Model Direct Steam Mixer Kettle Hand Tilt Std	1800/817
	TMKDL125T	Twin 125 Gallon (475 Liter Ea) Floor Model Direct Steam Mixer Kettle Hand Tilt Std	1890/857
	TMKDL150T	Twin 150 Gallon (575 Liter Ea) Floor Model Direct Steam Mixer Kettle Power Tilt Std	1990/903
OPTIONS (BUILT ON AT FACTORY)			
VOK1	380 Or 415 Volt, 50 Hz, 3 Phase For Electric Export		
VOK2	440/480 Volt, 60 Hz, 3 Phase		
PT3	Power Tilt (Standard On 150 Gallon Model Only)		
FBV2	2" Flush Bottom Ball Style Valve		
FPVA3	3" Air Operated Flush Piston Valve (KE003775-2) (Requires Air Compressor) For Pumping		
TD3A45	45 Degree Elbow with 8 Foot Hose To Be Used For 3" Tangent Draw Off or Butterfly Valve with Acme Thread		
TD3A90	90 Degree Elbow with 8 Foot Hose To Be Used For 3" Tangent Draw Off or Butterfly Valve with Acme Thread		
HS001	Front Mounted Removable Heat Deflector Shield		
SCK2	Steam Controls Kit (Trap, Strainer, Check Valve)		
MKDS2/316A	2" Mixer Drain Strainer 1/4" Holes		
MKDS3/316A	3" Mixer Drain Strainer 1/4" Holes		
CP-MKDL	Correctional Package -MKDL, TMKDL Mixer Kettles (Prison Screws And Screw Driver, Switch Guard, TD Valve Strap, Pressure Gauge Guard, Prison Control Cover)		
CONTROL OPTIONS (MKDL, TMKDL)			
GMC1/LMC1	Automatic Water Meter, Built Into Console Mounted (Specify Gallons Or Liters) Used With 3/4" Filler Hose, Replaces DPK Double Pantry Faucet		
AWC1	Automatic Water Cooling, Built Into Console (Direct Steam Kettles Only)		
DTCI	easyDial Digital Time and Temperature Control & Indicator with Data Logger and USB Port		

MIXER KETTLES, ELECTRIC, VERTICAL SWEEP & FOLD SERIES

ELECTRIC SWEEP & FOLD VERTICAL STEAM JACKETED MIXER KETTLES

Cleveland Floor Model Electric Mixer Kettles, Solid State Temperature Controls, 2" Tangent Draw-Off, Two Piece Hinged Cover With Built In Safety Screen, 50 PSI Steam Jacket Rating, Variable Speed Agitator With 0-70 RPM Scraper Blade, 0-210 RPM Secondary Agitator, 208-240 Volt - 3/4 Horse Power Belt Drive, Gallon or Liter Markings On Mixer Shaft (10 gallon/ 40 liters increments), Low Water LED Indicator Light, Manual Hand Tilt, 316 Stainless Steel Liner Standard, High Wattage Standard, DPK Double Pantry Faucet, Certified to Applicable CSA and NSF Standards, Australian Certification

PRODUCT SERIES	MODEL	DESCRIPTION	SHIP WT LBS/KGS
	MKEL40T	40 Gallon (150 Liter) Floor Model Electric Mixer Kettle Hand Tilt Std	820/369
	MKEL60T	60 Gallon (225 Liter) Floor Model Electric Mixer Kettle Hand Tilt Std	870/391
	MKEL80T	80 Gallon (300 Liter) Floor Model Electric Mixer Kettle Hand Tilt Std	1060/477
	MKEL100T	100 Gallon (375 Liter) Floor Model Electric Mixer Kettle Hand Tilt Std	1250/525
	TMKEL40T	Twin 40 Gallon (150 Liter Ea) Floor Model Gallon Electric Mixer Kettle Hand Tilt Std	1600/720
	TMKEL60T	Twin 60 Gallon (225 Liter Ea) Floor Model Gallon Electric Mixer Kettle Hand Tilt Std	1670/751
	TMKEL80T	Twin 80 Gallon (300 Liter Ea) Floor Model Gallon Electric Mixer Kettle Hand Tilt Std	1840/828
	TMKEL100T	Twin 100 Gallon (375 Liter Ea) Floor Model Gallon Electric Mixer Kettle Hand Tilt Std	2150/975
	PUMPABLE OPTIONS (BUILT ON AT FACTORY)		
	TD2A	2" Tangent Draw-Off Valve With Acme Thread (Special Order)	
	TD2A45	45 Degree Elbow with 8 Foot Hose To Be Used For 2" Tangent With Acme Thread	
	TD2A90	90 Degree Elbow with 8 Foot Hose To Be Used For 2" Tangent With Acme Thread	
	MKDS2/316A	2" Mixer Drain Strainer 1/4" Holes	
	OPTIONS & ACCESSORIES		
	ELEVATION	Specify If Over 3,000 Feet	
	VOK1	380 or 415 Volt, 50 Hz, 3 Phase For Electric Export	
	VOK2	440 or 480 Volt, 60 Hz, 3 Phase	
	HW2	High Wattage Option (Standard On Mixer Kettles)	
	PT3	Power Tilt Option	
	HS001	Front Mounted Removable Heat Deflector Shield	
CP-MKEL	Correctional Package -MKEL, TMKEL Mixer Kettles (Prison Screws And Screw Driver, Switch Guard, TD Valve Strap, Pressure Gauge Guard, Prison Control Cover)		
	CONTROL OPTIONS (BUILT ON AT FACTORY)		
	GMC1/LMC1	Automatic Water Meter, Built Into Console Mounted (Specify Gallons Or Liters) Used With 3/4" Filler Hose, Replaces DPK Double Pantry Faucet	
	EZD-DTCI	easyDial Digital Time and Temperature Control & Indicator with Data Logger and USB Port	

MIXER KETTLES, GAS, VERTICAL SWEEP & FOLD SERIES

SELF CONTAINED GAS SWEEP & FOLD VERTICAL STEAM JACKETED MIXER KETTLES

Cleveland Floor Model Gas Mixer Kettles, Solid State Temperature Controls, 3" Butterfly Valve With Acme Thread, Built In Two Piece Hinged Cover With Built In Safety Screen, 50 PSI Steam Jacket Rating, Variable Speed Agitator With 0-70 RPM Scraper Blade, 0-210 RPM Secondary Agitator, 3/4 Horse Power Belt Drive, Gallon or Liter Markings On Agitator Shaft (10 Gallon/40 Liter Increments), Low Water LED Indicator Light, DPK Double Pantry Faucet, Manual Hand Tilt, 316 Stainless Steel Liner Standard. Certified to Applicable UL, CSA and NSF Standards, CE Certification



PRODUCT SERIES	MODEL	DESCRIPTION	SHIP WT LBS/KGS
	MKGL40T	40 Gallon (150 Liter) Floor Model Gas Mixer Kettle Hand Tilt STD	850/386
	MKGL60T	60 Gallon (225 Liter) Floor Model Gas Mixer Kettle Hand Tilt STD	925/420
	MKGL80T	80 Gallon (300 Liter) Floor Model Gas Mixer Kettle Power Tilt STD	1000/454
OPTIONS & ACCESSORIES (MKGL)			
208-240	208-240 Volt, 60 Hz, 3 Phase Standard		
VOK1	380 or 415 Volt, 50 Hz, 3 Phase For Electric Export		
VOK2	440 or 480 Volt, 60 Hz, 3 Phase		
GAS TYPE	Specify: Natural, Propane, Butane, Manufactured, Town, Other		
ELEVATION	Specify Altitude If Over 2,000 Feet		
PT3	Power Tilt Option		
FBV2	2" Ball Style Valve (Contact Factory, 80, 100 Gallons Only)		
FPVA3	3" Air Operated Flush Piston Valve (KE003775-2) (Requires Air Compressor) For Pumping		
TD3A45	45 Degree Elbow with 8 Foot Hose To Be Used For 3" Tangent Draw Off or Butterfly Valve with Acme Thread		
TD3A90	90 Degree Elbow with 8 Foot Hose To Be Used For 3" Tangent Draw Off or Butterfly Valve with Acme Thread		
MKDS-3/316AS	3" Butterfly Valve Solid Drain Strainer - No Holes		
MKDS3/316A	3" Butterfly Valve Drain Strainer - 1/4" Holes		
HS001	Front Mounted Removable Heat Deflector Shield		
CP-MKGL	Correctional Package -MKGL Mixer Kettles (Prison Screws And Screw Driver, Switch Guard, Water Level Gauge Guard, Prison Control Cover)		
OPTIONS (BUILT ON AT FACTORY)			
208-240	208-240 Volt, 60 Hz, 3 Phase Standard		
VOK1	380 or 415 Volt, 50 Hz, 3 Phase For Electric Export		
VOK2	440 or 480 Volt, 60 Hz, 3 Phase		
CONTROL OPTIONS (MKGL)			
GMC1/LMC1	Automatic Water Meter, Built Into Console Mounted (Specify Gallons Or Liters) Used With 3/4" Filler Hose, Replaces DPK Double Pantry Faucet		
EZD-DTCI	easyDial Digital Time and Temperature Control & Indicator with Data Logger and USB Port		
ACCESSORIES			
DKFK	Double Pantry Kettle Filler (P/N 105979)		
PRSK	Pre Rinse Spray Hose (P/N B-0113)		
PCK	Self Leveling Pan Carrier (tilting models)		
DRAINPAN6	6" Deep, 12"x20" Stainless Steel Pan with Drain		
FD	Flow Diverter		
FS40	40 Gal food strainer		
FS12	12 Gal food strainer, electric direct steam models		
FS20	20 Gal food strainer		
FS60	60 Gal food strainer		
FS80	80 Gal food strainer		
TBS-25	Tri Basket System 25 Gal Models (includes 3 BS-3's)		
TBS-40	Tri Basket System 40 Gal Models (includes 3 BS-6's)		
TBS-60	Tri Basket System 60 Gal Models (includes 3 BS-6's)		
TBS-80	Tri Basket System 80 Gal Models (includes 3 BS-6's)		
TBS-40SH	Tri Basket System 40 Gal Models SH Series (Includes 3 BS-6's)		
SF3	Swing Drain Funnels for Tilting Kettles (KE003891-1, Floor Mounted)		
KAK	Kettle Accessory Kit, includes all items below (P/N 40880)		
KBK	Kettle Brush Kit (P/N 408802)		
CB	Clean Up Brush (P/N 00856)		
KP	Kettle Paddle (P/N 102405)		
KW	Kettle Whip (P/N 00961)		
KB	Kettle Brush (P/N 00853)		
DB	Draw Off Brush (P/N 00852)		

HA SERIES MIXER KETTLES, SELF CONTAINED GAS

HA Series (HAMKGL) Gas Mixer Kettles, Horizontal Agitator, Variable Speed Control, 3 HP Agitator Drive, Patented Gas Power Burner Design, Solid State Temperature Controls, 2" Tangent Draw Off, Built In Two Piece Spring Assist Cover With Built In Safety Screen, 50 PSI Steam Jacket Rating, Gallon Markings On Inside Kettle Jacket (10 Gallon/40 Liter Increments), Low Water LED Indicator Light, 316 Stainless Steel Liner Standard, DPK Double Pantry Faucet, Certified to Applicable CSA and NSF Standards

PRODUCT SERIES	MODEL	DESCRIPTION	SHIP WT LBS/KGS
	HAMKGL60CC	60 Gallon (225 Liter) HA Series Gas Mixer Kettle, Stationary	940/426
	HAMKGL80CC	80 Gallon (300 Liter) HA Series Gas Mixer Kettle, Stationary	1030/467
	HAMKGL100CC	100 Gallon (375 Liter) HA Series Gas Mixer Kettle, Stationary	1110/500
	HAMKGL60TCC	60 Gallon (225 Liter) HA Series Gas Mixer Kettle, Tilting, Power Tilt Standard	1010/458
	HAMKGL80TCC	80 Gallon (300 Liter) HA Series Gas Mixer Kettle, Tilting, Power Tilt Standard	1120/508
	HAMKGL100TCC	100 Gallon (375 Liter) HA Series Gas Mixer Kettle, Tilting, Power Tilt Standard	1325/601



ELECTRICAL AND GAS OPTIONS (HA-MKGL-T)

208-240	208-240 Volt, 60 Hz, 3 Phase Standard	
VOK1	380 volt, 50 Htz, 3 Phase	
VOK2	440-480 Volt, 60 Hz, 3 Phase	
GAS TYPE		
ELEVATION	Specify Altitude If Over 2,000 Feet	

ELECTRICAL AND GAS OPTIONS (HA-MKGL-T)

HA-FPVA3	3" Air Operated Flush Piston Valve (KE003775-2) (Requires Air Compressor) Standard on all HA Mixers	
BV3A	3" Butterfly Valve with Acme Thread (KE52286)	
HA-GMC1/LMC1	Model GMC/LMC1 - Automatic Water Meter (Gallons), Kettle Mounted (Specify Gallons or Liters) Used With 3/4" Filler Hose	
HA-EZ-DTCI	EasyDial Style Digital Time, Temperature Control And Indicator with Data Logger and USB Port for Downloading (Kettle Mounted)	
HA-DL	Data Logger with USB Port to Download Time and Temperature Data (must get HA-EZ-DTCI Option)	
HA-HMI	15" HMI Touchscreen Style Controller with Digital Time, Temperature Control Indicator with Data Logger, USB Port for Downloading and Automatic Water Meter with Kettle Filler Hose (Kettle Mounted)	
CP-HAMKGL	Correctional Package -HA-MKGL Mixer Kettles (Prison Screws And Screw Driver, Switch Guard, Water Level Gauge Guard, Prison Control Cover)	

CONTROL OPTIONS (REMOTE FLOOR MOUNTED)

HASGCH	Single Floor Mount, Remote Control Center For HA-MKGL Includes EasyDial Style Digital Time, Temperature Control And Indicator with Data Logger and USB Port for Downloading	650/295
HASGLC	Lockable Control Center For Prisons	

CONTROL OPTIONS (REMOTE FLOOR MOUNTED)

KE55336-1	90 Degree Reducer, 3" Acme Tread To 2" Acme Thread Reducer	
KE55336-2	90 Degree Reducer, 3" Sani Clamp To 2" Acme Thread Reducer	
KE55336-3	45 Degree Reducer, 3" Sani Clamp To 2" Acme Thread Reducer	
KE55336-4	90 Degree Elbow, 2" Sani Clamp To 2" Acme Thread Reducer	
KE55336-5	45 Degree Elbow, 2" Sani Clamp To 2" Acme Thread Reducer	
KE55336-6	90 Degree Elbow, 3" Acme Thread To 3" Acme Thread Reducer	
KE55336-7	90 degree Elbow, 3" acme thread to 2" Sani Clamp	
KE55336-8	Straight, 3" acme thread to 2" Sani Clamp	
Q60234	3" Ball Valve Adapter - Acme tread both ends, attached to 3" Air Piston Valve	
KE52286	3" Butterfly Valve Adapter - Acme tread both ends, attached to 3" Air Piston Valve	
KE0204404	3" Tangent Draw-Off Adapter - Acme tread both ends, attached to 3" Air Piston Valve	

ACCESSORIES

AGD-1	Agitator Dolly Up To 100 Gal. Kettle Capacity	
HA-SL (1A599)	(1A599) Sling For Agittor Lifting (3" X 6 Feet)	
KE55336-6	90 Degree 3" Diameter Elbow With Acme Thread	
FS-60-HA	60 Gallon Half Moon Strainer, HA Series Mixer Kettles (pn KE02373-1) (Tilting Models only)	

HA SERIES MIXER KETTLES, DIRECT STEAM

Model HAMKDL Series - Direct Steam Mixer Kettles, HA-Series, Horizontal Agitator, Variable Speed Control, 3 HP Agitator Drive, 3" Air Piston Valve, Built In Two Piece Spring Assist Cover With Built In Safety Screen, 70 Psi Steam Jacket Rating, 316 Stainless Steel Liner Standard, DPK Double Pantry Faucet, Gallon Markings On Inside Kettle Jacket (10 Gallon/40 Liters Increments), Certified to Applicable UL, CSA and NSF Standards



PRODUCT SERIES	MODEL	DESCRIPTION	SHIP WT LBS/KGS
	HAMKDL60CC	60 (225 Liter) Gallon Ha Series Direct Steam Mixer Kettle, Stationary	940/426
	HAMKDL80CC	80 (300 Liter) Gallon Ha Series Direct Steam Mixer Kettle, Stationary	985/447
	HAMKDL100CC	100 Gallon (375 Liter) Ha Series Direct Steam Mixer Kettle, Stationary	1030/467
	HAMKDL200CC	200 Gallon (757 Liter) Ha Series Direct Steam Mixer Kettle, Stationary	1110/500
	HAMKDL60TCC	60 Gallon (225 Liter) Ha Series Direct Steam Mixer Kettle, Tilting, Power Tilt Standard	1010/458
	HAMKDL80TCC	60 Gallon (300 Liter) Ha Series Direct Steam Mixer Kettle, Tilting, Power Tilt Standard	1065/484
	HAMKDL100TCC	100 Gallon (375 Liter) Ha Series Direct Steam Mixer Kettle, Tilting, Power Tilt Standard	1120/508
	HAMKDL200TCC	200 Gallon (747 Liter) Ha Series Gas Mixer Kettle, Tilting, Power Tilt Standard	1325/601

OPTIONS (HAMKDL, HA-MKDL-T)

208-240	208-240 Volt, 60 Hz, 3 Phase Standard
VOK1	380-415 volt, 50 Htz, 3 Phase
VOK2.1	440 volt, 60 Htz, 3 Phase Option
VOK2.2	480 Volt, 60 Hz, 3 Phase
CP-HAMKDL	Correctional Package -Ha-Mkdl Mixer Kettles (Prison Screws And Screw Driver, Switch Guard, Water Level Gauge Guard, Prison Control Cover)

CONTROL AND PUMPABLE OPTIONS, KETTLE CONSOLE MOUNTED

HA-FPVA3	3" Air Operated Flush Piston Valve (KE003775-2) (Requires Air Compressor) Standard on HA Mixers
BV3A	3" Butterfly Valve with Acme Thread (KE52286)
FBV2	2" Ball Valve
HA-GMC1/LMC1	Automatic Water Meter (Gallons), Built Into Console Mounted (Specify Gallons Or Liters) Used With 3/4" Filler Hose, Replaces Dpk Double Pantry Faucet
HA-DTCI	(DTCI) Digital Temperature Control And Indicator with built in cooking probe with Data Logger and USB Port for Downloading time and temperature data (Kettle Mounted)
HA-DL	Data Logger with USB Port to Download Time and Temperature Data (must get HA-DTCI Option)
HA-AWC1	Automatic Water Cooling, Built Into Console (Direct Steam Kettles Only)

CONTROL AND PUMPABLE OPTIONS, KETTLE CONSOLE MOUNTED

HASECH	Single Floor Mount, Remote Control Center For HA-MKGL Includes EasyDial Style Digital Time, Temperature Control And Indicator with Data Logger and USB Port for Downloading	650/295
HASELC	Lockable Control Center For Prisons	

ACCESSORIES ADAPTERS (ELBOWS AND REDUCERS)

KE55336-1	90 Degree Reducer, 3" Acme Tread To 2" Acme Thread Reducer
KE55336-2	90 Degree Reducer, 3" Sani Clamp To 2" Acme Thread Reducer
KE55336-3	45 Degree Reducer, 3" Sani Clamp To 2" Acme Thread Reducer
KE55336-4	90 Degree Elbow, 2" Sani Clamp To 2" Acme Thread Reducer
KE55336-5	45 Degree Elbow, 2" Sani Clamp To 2" Acme Thread Reducer
KE55336-6	90 Degree Elbow, 3" Acme Thread To 3" Acme Thread
KE55336-7	90 degree Elbow, 3" acme thread to 2" Sani Clamp
KE55336-8	Straight, 3" acme thread to 2" Sani Clamp
Q60234	3" Ball Valve Adapter - Acme tread both ends, attached to 3" Air Piston Valve
KE52286	3" Butterfly Valve Adapter - Acme tread both ends, attached to 3" Air Piston Valve
KE0204404	3" Tangent Draw-Off Adapter - Acme tread both ends, attached to 3" Air Piston Valve
SCK2	SCK2 - Steam Controls Kit (Trap, Strainer, Check Valve) Accessory
HS001	Front Mounted Removable Heat Deflector Shield
CP-HAMKDL	Correctional Package -Ha-Mkdl Mixer Kettles (Prison Screws And Screw Driver, Switch Guard, Water Level Gauge Guard, Prison Control Cover)

HA SERIES MIXER KETTLES

PRODUCT SERIES	MODEL	DESCRIPTION	SHIP WT LBS/KGS
ACCESSORIES			
AGD-1		Agitator Dolly Up To 100 Gal. Kettle Capacity	
HA-SL (1A599)		(1A599) Sling For Agittor Lifting (3" X 6 Feet)	
FS-60-HA		60 Gallon Half Moon Strainer, HA Series Mixer Kettles (pn KE02373-1) (Tilting Models only)	
FS-100-HA		100 Gallon Half Moon Strainer, HA Series Mixer Kettles (pn KE02373-3) (Tilting Model only)	
FS-200-HA		100 Gallon Half Moon Strainer, HA Series Mixer Kettles (pn KE02373-?) (Tilting Model only)	

HA SERIES MIXER KETTLES

HA SERIES MIXER KETTLES, SELF CONTAINED ELECTRIC

HA Series (HAMKEL) Electric Mixer Kettles, Horizontal Agitator, Variable Speed Control, 3 HP Agitator Drive, Solid State Temperature Controls, 3" Tangent Draw Off Valve w/Male Acme Thread, Built In Two Piece Spring Assist Cover With Built In Safety Screen, 50 PSI Steam Jacket Rating, Gallon Markings On Inside Kettle Jacket (10 Gallon/40 Liter Increments), Low Water LED Indicator, Certified to CSA and NSF standards Light, 316 Stainless Steel Liner Standard, DPK Double Pantry Faucet, Certified to Applicable UL, CSA and NSF Standards









PRODUCT SERIES	MODEL	DESCRIPTION	SHIP WT LBS/KGS
	HAMKEL60CC	60 Gallon (225 Liter) HA Series Electric Mixer Kettle, Stationary	940/426
	HAMKEL80CC	80 Gallon (300 Liter) HA Series Electric Mixer Kettle, Stationary	1030/467
	HAMKEL100CC	100 Gallon (375 Liter) HA Series Electric Mixer Kettle, Stationary	1110/500
	HAMKEL60TCC	60 Gallon (225 Liter) HA Series Electric Mixer Kettle, Tilting, Power Tilt Standard	1010/458
	HAMKEL80TCC	80 Gallon (300 Liter) HA Series Electric Mixer Kettle, Tilting, Power Tilt Standard	1120/508
	HAMKEL100TCC	100 Gallon (375 Liter) HA Series Electric Mixer Kettle, Tilting, Power Tilt Standard	1325/601
OPTIONS			
	208-240	208-240 Volt, 60 Hz, 3 Phase Standard	
	VOK1	380 volt, 50 Htz, 3 Phase	
	VOK2	440-480 Volt, 60 Hz, 3 Phase	
	HA-GMC1/LMC1	Model GMC/LMC1 - Automatic Water Meter (Gallons), Kettle Mounted (Specify Gallons or Liters) Used With 3/4" Filler Hose for Standard Manual Controls	
	HA-HMI	15' HMI Touchscreen Style Controller with Digital Time, Temperature Control Indicator with Data Logger, USB Port for Downloading and Automatic Water Meter with Kettle Filler Hose (Kettle Mounted)	
	CP-HAMKEL	Correctional Package -HA-MKGL Mixer Kettles (Prison Screws And Screw Driver, Switch Guard, Water Level Gauge Guard, Prison Control Cover)	
	HASECH	Single Floor Mount, Remote Control Center For HA-MKEL Includes 15' HMI Touchscreen Style Controller with Digital Time, Temperature Control And Indicator	
	HASELC	Lockable Control Center For Prisons	
	KE55336-6	90 Degree Elbow, 3" Acme Thread To 3" Acme Thread Reducer	
ACCESSORIES			
	AGD-1	Agitator Dolly Up To 100 Gal. Kettle Capacity	
	HA-SL (1A599)	(1A599) Sling For Agitator Lifting (3" X 6 Feet)	
	KE55336-6	90 Degree 3" Diameter Elbow With Acme Thread	
	FS-60-HA	60 Gallon Half Moon Strainer, HA Series Mixer Kettles (pn KE02373-1) (Tilting)	
	FS-80-HA	80 Gallon Half Moon Strainer, HA Series Mixer Kettles (pn KE02373-2) (Tilting Model)	
	FS-100-HA	100 Gallon Half Moon Strainer, HA Series Mixer Kettles (pn KE02373-3) (Tilting)	

PASTA KETTLES- DIRECT STEAM

PASTA KETTLES- DIRECT STEAM

Model PKDL Series - Direct Steam Pasta Kettle, 50 PSI Steam Jacket Rating, 2/3rds Steam Jacketed, 316 Stainless Steel Interior. 3" Air Piston Valve standard Overflow catch pan with overflow drain, water fill faucet with swing spout, Steam Control Kit. Certified to CSA, CE and NSF standards

PRODUCT SERIES	MODEL	DESCRIPTION	SHIP WT LBS/KGS
	PKDL60	60 gallon Pasta Kettle	
	PDKL80	80 Gallon Pasta Kettle	
	PKDL100	100 gallon Pasta Kettle	
	PKDL200	200 Gallon Pasta Kettle	
ELECTRICAL OPTIONS (PASTA KETTLES)			
	208-240	208-240 Volt, 60 Hz, 3 Phase Standard	
	VOK2	440-480 Volt, 60 Hz, 3 Phase	
CONTROL OPTIONS, KETTLE CONSOLE MOUNTED			
	HA-FPVA3	3" Air Operated Flush Piston Valve (KE003775-2) (Requires Air Compressor) Standard on Pasta Kettles	
	HA-GMC1/LMC1	Automatic Water Meter (Gallons), Built Into Console Mounted (Specify Gallons Or Liters) Used With 3/4" Filler Hose, Replaces Dpk Double Pantry Faucet	
	HA-DTCI-DL	(DTCI) Digital Temperature Control And Indicator with built in cooking probe with Data Logger and USB Port for Downloading time and temperature data (Kettle Mounted)	
	HA-AWC1	Automatic Water Cooling, Built Into Console (Direct Steam Kettles Only)	
	SCK2	SCK2 - Steam Controls Kit (Trap, Strainer, Check Valve) Accessory	
	HS001	Front Mounted Removable Heat Deflector Shield	
	CP-HAMKDL	Correctional Package -Ha-Mkdl Mixer Kettles (Prison Screws And Screw Driver, Switch Guard, Water Level Gauge Guard, Prison Control Cover)	
CONTROL OPTIONS, REMOTE FLOOR MOUNTED			
	HASECH	Single Floor Mount, Remote Control Center For Pasta Kettles with DTCI Temperature Control, DL- Datas Logger, AWC1 Automatic Water Cooling.	
	HASELC	Lockable Control Center For Prisons	
PASTA BASKETS & DOLLY'S			
	PBK-60	60 Gallon Pasta Basket	
	PBK-80	80 Gallon Pasta Basket	
	PBK-100	100 Gallon Pasta Basket (Q10322-7-A)	
	PBK-200	200 Gallon Pasta Basket	
	PBD-60	Dolly For 60 Gallon Pasta Basket	
	PBD-80	Pasta Dolly For 80 Gallon Pasta Basket	
	PBD-200	Pasta Dolly For 200 Gallon Pasta Basket	





PRODUCT SERIES	MODEL	DESCRIPTION	SHIP WT LBS/KGS
	MFS	Piston Style Metering Filling Station: Standard With Selector Switch For Single or Continuous Operation, Adjustable Piston Stroke From 20 - 128 Oz, Adjustable Speed Control For Suction and Filling, Cabinet With Hinged Doors and Casters, Sink With Drain And Lift Off Wire Rack. Includes (2)3 Foot Long 3" Dia. Food Grade Hoses, (1) CO-6 2" Dia. Green Cleaning Hose,(1) Pan Filler Assembly (PF), 90 Degree Elbow (MFSHEA), Clean Up Brush Kit (CBK-CC), Food Grade Grease (KE54167), two trash containers (KE603751), two Air hoses for Clipper and MFS (KE01518, KE01750), Certified to Applicable NSF Standards (Note: Requires Compressed Air - 25 CFM @80-100 PSI)	475/215
	SZ-4135L	Casing Clipper (not included in price of MFS Food Pump)	75/34
	MFS ACCESSORIES		
	MFSHEA	3" Diameter, 90 Degree Elbow (KE55336-6) (Included with purchase of MFS Food	
	PF	Pan Fill, includes 45 degree elbow (FI05300), 2" Vertical Pipe (KE01316-3) (Included with purchase of MFS Food Pump)	
	MFS-HO-6	Two 3' Foot long 3" Food Grade Hose, 6 Feet Long With Fittings (KE01749-2, KE01749-3) (Included with purchase of MFS Food Pump)	
	MFS-CO6	Green Cleaning Hose, 6' Long. 2" diameter, (KE01333)	
		18" - 3" diameter food hose Bevel Seat with Acme Nut One End and Acme Thread Only Other End	
	CBK-CC	Clean Up Brush Kit, (KE01776) (Included with purchase of MFS Food Pump)	
	KE54167	Food Grade Grease (Included in price)	
	KE603751	Trash Containers KE603751) (two included with purchase of MFS)	
	KE01518	Air Hose for Clipper KE01518) (included with purchase of MFS Food pump)	
	KE01750	Air Hose for MFS Food Pump (8' 6" Long - KE01750) (included with purchase of MFS Food pump)	
	CLIPS AND BAGS		
	Z401C	Clips For SZ4135L Clipper (25,000 Per Case)	
	Z401B	Clips For SZ4135L Clipper (6,250 Per Box)	
	B-BB1-1024HS	FLAVORSEAL 4.3 mil. 10 x 24 One Gallon Bags no handle, heat seal one end, 500 per case (heavy chunking products)	
	B-BB1-1024HS3	FLAVORSEAL 3.0 mil. 10 x 24 One Gallon Bags no handle, heat seal one end, 500 per case (soupy products)	
	G-CL-4008	Replacement Clips from Flavor Seal (25,000 per case)	
	KE53039	Cylinder for clipper	
	ELBOWS AND REDUCERS		
	KE55336-1	90 Degree Reducer, 3" Acme Tread To 2" Sani Clamp (Tri-Clover) Reducer	
	KE55336-2	90 Degree Reducer, 3" Sani Clamp To 2" Sani Clamp (Tri-Clover) Reducer	
	KE55336-3	45 Degree Reducer, 3" Sani Clamp To 2" Sani Clamp (Tri-Clover) Reducer	
	KE55336-4	90 Degree Elbow, 2" Sani Clamp To 2" Sani Clamp (Tri-Clover) Reducer	
	KE55336-5	45 Degree Elbow, 2" Sani Clamp To 2" Sani Clamp (Tri-Clover) Reducer	
	KE55336-6	90 Degree Elbow, 3" Acme Thread To 3" Sani Clamp (Tri-Clover)	
	VACUUM CLIPPING MACHINES		
	TT VAC-H CVW (CV4100)	CVW Clipper Machine FOR WHOLE MEATS - Includes AZ-24100LM Clipper, Vacuum Pump, Casters, (Note: Requires Compressed Air - 18 CFM @80-100 PSI)	85
	TT VAC-V (CVESZ4135L)	CVE Clipper Vacuum Machine FOR LIQUID PRODUCTS, includes SZ4135L Left Handed Clipper, Shut Off Nozzle, Casters, Waste Tank, White Oil, Hose Assembly,	85
	SZ4135L	Additional Clipper for CVE	
	00-8065	Shut Off Nozzle (included with CVE)	
	00-0478	Caster Kit For CVE (Included with CVE)	
	RS	Model RS Ring Stand For Hand-Filling	

TURBOJET II, PRODUCT CHILLERS AND COOK TANKS

PRODUCT SERIES	MODEL	DESCRIPTION	SHIP WT LBS/KGS
 	HBC075 (TJHBC075)	Model HBC075, Cleveland Turbojet II 75 Gallon (657Lbs) Product Chill Tank Is Designed To Supply A 35-40° F Water Bath For Cooling 75 Gallons Of Product From 180°F To 40° F, The Product Cooler Is Designed To Provide Turbulent Flow Throughout The Cooler. The Turbulent Flow Provides The Most Optimum Rapid Cooling Possible, Certified to Applicable UL, CSA and NSF Standards	1,610
	HBCC075 (TJHBCC075)	Model HBCC075 Cleveland Turbojet II 75 Gallon (657Lbs) Product Cooker And Chill Tank Is Designed To Supply 180 Degree Circulated Water Bath For Cooking And A 35-40° F Water Bath For Cooling 75 Gallons Of Product From 180°F To 40° F, The Product Cooker And Cooler Is Designed To Provide Turbulent Flow Throughout The Unit. The Turbulent Flow Provides The Most Optimum Rapid Cooking And Cooling Possible. Load Height Shall Be 42", Certified to Applicable UL, CSA and NSF Standards	1,735
HBC, HBCC75 OPTIONS			
FSD	Fuse Disconnect Switch		
LCH0080MC-ACD	Remote Mounted 8 Hp Air Cooled Condensing Unit (Outdoor Unit)		1,020
LRU1010ABAM6V2	10 Hp Air Cooled (380 V/50 Htz 3 Ph For China)		1,020
LRU1008	Remote Mounted 8 Hp Water Cooled Condensing Unit (Indoor Unit)		1,100
VOSC3	480 Volt, 60 Hz, 3 Phase		
DTK100	Drain Tempering Kit System to Cool drain water below 140oF (for HBCC models)		
SSBOLT	Stainless Steel Bolting Harware for eight (8) Leg Flanges		
DDR	Paperless Digital Time/Temperature Recorder With USB Port		
 	HBC100 (TJHBC100)	Model HBC100, Cleveland Turbojet II 100 Gallon (900 Lbs) Product Chill Tank Is Designed To Supply A 35-40° F Water Bath For Cooling 75 Gallons Of Product From 180°F To 40° F, The Product Cooler Is Designed To Provide Turbulent Flow Throughout The Cooler. The Turbulent Flow Provides The Most Optimum Rapid Cooling Possible, Certified to Applicable UL, CSA and NSF Standards	1,850
	HBCC100 (TJBCC100)	Model HBCC100 Cleveland Turbojet II 100 Gallon Product Cooker And Chill Tank Is Designed To Supply 180 Degree Circulated Water Bath For Cooking And A 35-40° F Water Bath For Cooling 75 Gallons Of Product From 180°F To 40° F, The Product Cooker And Cooler Is Designed To Provide Turbulent Flow Throughout The Unit. The Turbulent Flow Provides The Most Optimum Rapid Cooking And Cooling Possible. Load Height Shall Be 42, Certified to Applicable UL, CSA and NSF Standards	1950
HBC, HBCC100OPTIONS			
FSD	Fuse Disconnect Switch		
LCV0150M-ACD	Remote Mounted 15 Hp Air Cooled Condensing Unit (Outdoor Unit) North America 60 Htz) 208-230 volt model		1,580
LDV0150M-ACD	Remote Mounted 15 Hp Air Cooled Condensing Unit (Outdoor Unit) 380 volt/ 50 hts, 3 phase		1,580
LDV0150M-ACD	Remote Mounted 15 Hp Air Cooled Condensing Unit (Outdoor Unit) 208-140 volt/ 60 hts, 3 phase, 8,500 foot elevation Colsubidio		1,580
LCV0220MDABX	22 Hp Air Cooled For 380 volt (For Export)		
LCV0250MDABX	25 HP Air cooled compressor for Chile project, compass group. 380 volt, 12,000 foot elevation		
LRU2040WBAM6V1	Special Dual Circuit 40 Hp (20 Hp Ea) Water Cooled Condensing Unit (China.Vietnam)		
LRU1040WBAM6V1	Special 20 Hp (20 Hp Ea) Water Cooled Condensing Unit (China.Vietnam)		
BOILER STEAM	Steam Heat Option - Contact Girton		
LRU1015	Remote Mounted 15 Hp Water Cooled Condensing Unit (Indoor Model)		1,200
VOSC3	480 Volt, 60 Hz, 3 Phase		
VOSC4	380 volt /50 Htz/3 Phase		
DTK100	Drain Tempering Kit (For HBCC100 models)		
SSBOLT	Stainless Steel Bolting Harware for eight (8) Leg Flanges		
DDR	Paperless Digital Time/Temperature Recorder With Usb		
HBC200			
HBC200 (TJHBC200)	Model No. HBC200, Cleveland Turbojet II 200 Gallon (1,700 Lbs) Product Chill Tank Is Designed To Supply A 35-40° F Water Bath For Cooling 75 Gallons Of Product From 180°F To 40° F, The Product Cooler Is Designed To Provide Turbulent Flow Throughout The Cooler. The Turbulent Flow Provides The Most Optimum Rapid Cooling Possible, Certified to Applicable UL, CSA and NSF Standards		

PRODUCT SERIES	MODEL	DESCRIPTION	SHIP WT LBS/KGS
HBC200 OPTIONS			
LCV0300MDADX0608		Remote Mounted 30 Hp Air Cooled Condensing Unit, (Dims: 171" Long X 45" Wide	1,860
LRU1035ABAM6V2		35 Hp Air Cooled For Apac	
LRU1030WBA		Remote Mounted 30 Hp Water Cooled Condensing Unit,	1.35
FSD		Fuse Disconnect Switch (china)	
VOS2C		480 Volt, 60 Hz, 3 Phase	
91744		Stainless Steel Bolting Harware for eight (8) Leg Flanges	
DDR		Paperless Digital Time/Temperature Recorder With Usb Port	
COOKING BASKET & ACCESSORIES FOR COOK/CHILL TANKS			
		Cooking Baskets, Lift Out Carriers and Dolly's are for cooking and chilling meats.	
BAK152A		Additional Set of 10 Cooking Baskets 19-1/4" X 18-1/4" X 9" Quantity Holds 10 Ea	
BD152A		Case Truck Basket Dolly For Bak152A Cooking Baskets Holds 8 Bak152 Baskets	
LOBC152		Lift Out Cooking Cooling Basket Carrier With Lifting Bar (Holds 10 BAK152A Baskets)	
LOBCD152		Dolly For Use With LOBC152 Basket Carrier.	
SSBH		Stainless Steel Bolting Harware for eight (8) Leg Flanges	
HDB		Additional Hold Down Bars for HBC200 to hold BAK152A baskets	
KOLPAK BY CLEVELAND			
KBC750BC-2T		Modular Walk in blast chiller 850 lb chilling capacity for 2 carts, Interior plus	
KBC1500BC-3T		Modular Walk in blast chiller 1,200 lb chilling capacity for 3 carts, Interior plus floor	
OPTIONS FOR KOLPAK BY CLEVELAND			
LCH0075CACDC2754		7.5 HP Air cooled remote, outdoor condensing unit for KBC750BC-2T	
LCH0150LCACDC1997		15 HP Air cooled remote, outdoor condensing unit for KBC1500BC-3T	
KBCSD		Second Door for roll through application	
KBCRL		Reverse Layout	
KBCDV		Door Viewports	
KBCER		External Ramps	
KBCKP		Kick Plates	
KBCODW26		Optional door Width 26"	
KBCODW28		Optional door Width 28"	
KBCODW30		Optional door Width 30"	
KBCCH		Polished or Brushed Chrome hardware	



PRODUCT SERIES	MODEL	DESCRIPTION	SHIP WT LBS/KGS
	CAS5	Model CAS5, 18 CFM Compressed Air System, Consisting Of Air Compressor And Receiver Tank, 5 H.P., High Efficiency Blador Motor With Magnetic Starter, Auto Start And Stp Control, Balanced Extnal & Internal Pump 1/2" Combination Filter, Pressure Regulator 80 Gallon Receiver Tank , Certified to Applicable UL, CSA and	200
	CAS-AHT-20	Refrigerated Air Dryer For CAS-5	100
	CAS7.5	Model CAS7.5, 23.5 CFM Compressed Air System, Consisting Of Air Compressor And Receiver Tank, 7.5 H.P., High Efficiency Blador Motor With Magnetic Starter, Auto Start And Stop Control, Balanced ExTernal & Internal Pump 1/2" Combination Filter, Pressure Regulator 80 Gallon Receiver Tank, Certified to Applicable UL, CSA and NSF Standards	275
	CAS-AHT-25	Refrigerated Air Dryer For Cas-7.5	125
	CAS10	Model CAS10, 32.4 CFM Compressed Air System, Consisting Of Air Compressor And Receiver Tank, 10 H.P., High Efficiency Blador Motor With Magnetic Starter, Auto Start And StOp Control, Balanced ExTernal & Internal Pump 1/2" Combination Filter, Pressure Regulator 120 Gallon Receiver Tank	815
	CAS-AHT-35	Refrigerated Air Dryer For CAS-10	105
	CAS15	Model CAS15, 46.2 CFM Compressed Air System, Consisting Of Air Compressor And Receiver Tank, 15 H.P., High Efficiency Blador Motor With Magnetic Starter, Auto Start And Stp Control, Balanced Extnal & Internal Pump 1/2" Combination Filter, Pressure Regulator 120 Gallon Receiver Tank	984
	CAS-AHT-50	Refrigerated Air Dryer For CAS-15	125
	CAS20	Model CAS20, 58.4 CFM Compressed Air System, Consisting Of Air Compressor And Receiver Tank, 20 H.P., High Efficiency Blador Motor With Magnetic Starter, Auto Start And Stp Control, Balanced Extnal & Internal Pump 1/2" Combination Filter, Pressure Regulator 120 Gallon Receiver Tank	415
	CAS-AHT-75	Refrigerated Air Dryer For CAS-20	130

ACCESSORIES FOR ALL AIR COMPRESSORS

CAS-APD	Auto-Programable Drain Valve For CAS 90908-08	
CAS-VAP	Vibration Pads (Set Of 4) For Cas	
CAS-SSF	3/4" Stainless Steel Flex Hose For Cas	

HOIST AND RAIL SYSTEMS



CHH0510M	Electric Motorized Chain Hoist for Monorail System, one half ton capacity, food	275
CHH101M	CHH101M: 1 ton capacity electric chain hoist for Food Grade application, FDA approved white paint, 10-ft lift at 8-fpm hook speed, motor driven trolley with VFD 2-speed control, NEMA 3R enclosures with IPCC seals	275
CHR10SS	10 Foot Length Stainless Steel Rail with hardware, end stops, 6-ft hanger rod length (3) hanger rod assemblies including rod, beam clamps, brackets, load nuts	20 lbs. /ft
CHSSH1	Stainless Steel Load Hook For 1 Ton Load Capacity hoist	
CHSSCH1	Stainless Steel Load Chain For 1 Ton Load Capacity	
CHSSCH	Stainless Steel Chain Container, for 1-ton capacity, CH-H101-M hoist, 10 foot lift	
CH-CR20/SB	Cord Reel with 17 feet active reach swivel base and kellums grips	60 bs
CH-SSW1	Stainless steel wheels for motor driven trolley	

HOIST OPTIONS

CHSSH1	Stainless Steel Load Hook For 1 Ton Load Capacity hoist, increases headroom from	
CHR102M	Motorized Electric Chain Hoist 2 Ton Capacity	325
CHR10SS	10 Foot Length Stainless Steel Rail with hardware, end stops, 6-ft hanger rod length (3) hanger rod assemblies including rod, beam clamps, brackets, load nuts	20 lbs. /ft
CHR20SS	19.6 Foot Length Stainless Steel Rail with hardware, end stops, 6-ft hanger rod length (3) hanger rod assemblies including rod, beam clamps, brackets, load nuts	20 lbs. /ft
CHR30SS	19.6 Foot Length Stainless Steel Rail with hardware with 2 end stops, 6 foot hanger rod length (3) hanger assemblies including rod, beam clamps, brackets, load nuts	20 lbs. /ft
CHCR20/SB	Cable Reel With Swivel Base. 20 Foot Long Cord (17 ft active)	60 bs
CHCR30/SB	Cable Reel With Swivel Base. 30 Foot Long Cord (27 ft active)	60 bs
RADIO-CONDUCTIX	Conductix Model XA-700PRO6DHT radio, 4 button, 2 speed buttons, emergency stop, 2 alkaline batteries, 2 transmitters, NEMA 4 rated, 6' cable	
CHSFC	Stainless Steel Festoon Cable, 20 Feet Incl. Power Ord	
CHIRC	Infrared Remote Control Unit For Cm Hoist	5 lbs.
CHSSH1	Stainless Steel Load Hook For 1 Ton Load Capacity hoist, increases headroom from 15'6" to 18'7"	
CHSSH2	Stainless Steel Load Hook For 2 Ton Load Capacity	
CHSSCH	Stainless Steel Load Chain For 1 Ton Load Capacity	
CHSSCHC	Stainless Steel Chain Container, for 1-ton capacity, CH-H101-M hoist, 10 foot lift	
CHHRA8	Alloy Steel Hanger Rod assembly kit with special rolled thread for foodservice (9 required for 20 foot rail)	

PRODUCT SERIES	MODEL	DESCRIPTION	SHIP WT LBS/KGS
----------------	-------	-------------	--------------------

MISCELLANEOUS ACCESSORIES

PLSK24	SC-1913 (Plsk-24) Storage Crates - 19" X 13"
BD2028S	BD2028S - Stainless Steel Cook Chill Storgae Dolly 20 X 28
BD2028A	BD20208A - Alluminum Cook Chill Storgae Dolly 20 X 28
CBK-CC	Cleaning Brush Kit (KE01776) CB Consists of CB-Clean Up Brush, DB-Draw Off Brush, 3" Diameter Brush with 12" Handle, 6" long Hand Floater Brush, Rack for



Horizontal (HA) Series C/C Mixer Kettles Tilting & Stationary

Ideal for all applications, especially heavier foods like ground beef, meat sauces, mashed potatoes that requires superior mixing capabilities.

50 PSI steam jacket rating. Optional higher PSI steam jackets available.



DIRECT STEAM TILTING

- HAMKDLC60TCC
- HAMKDLC100TCC
- HAMKDLC200TCC

STATIONARY

- HAMKDLC60TCC
- HAMKDLC100TCC
- HAMKDLC200TCC



SELF-CONTAINED GAS

TILTING

- HAMKGL60TCC
- HAMKGL80TCC
- HAMKGL100TCC

STATIONARY

- HAMKGL60CC
- HAMKGL80CC
- HAMKGL100CC



SELF-CONTAINED ELECTRIC

TILTING

- HAMKEL60TCC
- HAMKEL80TCC
- HAMKEL100TCC

STATIONARY

- HAMKEL60CC
- HAMKEL80CC
- HAMKEL100CC



EXCLUSIVE HORIZONTAL AGITATOR DESIGN

Lifts and folds heavy, delicate, chunky, thick or thin products.

TOTALLY ENCLOSED SPRING LOADED AGITATOR BLADES

Hold tight against kettle surface for effective scraping.

NO COLD ZONES

Continuously scoops and folds the center of the product for faster cooking.

VARIABLE SPEED CONTROL AND INDICATOR

Adjustable from 5-24 RPM for a variety of applications.

SUPERIOR TEMPERATURE PROBE DESIGN

Located at the bottom of the kettle for accuracy down to the final emptying of the product.

DESIGNED FOR EASY CLEANING

Easy to rotate and remove agitator paddles without tools.

SINGLE PIECE DOME HINGED COVER

Increases productivity by retaining heat, improves food quality by keeping air out and steam in, improves safety because kettle cover is closed during cooking.

Sweep & Fold Series Tilting & Stationary C/C Mixer Kettles

Standard with 3" air operated flush piston valve for pumping, 316 stainless steel, console mounted Digital Time/ Temperature Control, Chart Recorder and Automatic Water Meter.

Ideal for soups, sauces, gravies, salad dressings, pie fillings.

50 PSI up to 100 gallons, 35 PSI on 125 gallons & larger.

SELF-CONTAINED ELECTRIC

TILTING

- MKEL40T
- MKEL60T
- MKEL80T
- MKEL100T



DIRECT STEAM

- MKDL40TCC
- MKDL60TCC
- MKDL80TCC
- MKDL100TCC
- MKDL125TCC
- MKDL150TCC



SELF-CONTAINED GAS

- MKGL40TCC
- MKGL60TCC
- MKGL80TCC

COOK CHILL FOR PUMPABLE PRODUCTS

1. COOK:

STEAM JACKETED KETTLES WITH PUMPABLE OPTION OR MIXER KETTLES (STANDARD WITH PUMPABLE OPTIONS)



2. PUMP

CLEVELAND MFS FOOD AND TRANSFER PUMP



3. CHILL

TURBOJET II WATER BATH CHILLERS AND KOLPAK BY CLEVELAND BLAST CHILLERS



4. STORE

REFRIGERATED INVENTORY STORAGE



COOK CHILL FOR NON-PUMPABLE PRODUCTS

1. VACUUM SEAL

VACUUM SEALER AND PACKAGING MACHINE



2. COOK-N-CHILL

CLEVELAND TURBOJETT II WATER BATH COOKER AND CHILLER



3. STORE

REFRIGERATED INVENTORY STORAGE



EXCLUSIVE SWEEP & FOLD AGITATOR DESIGN

UNIQUE TRIPLE ACTION AGITATOR DESIGN FOR SUPERIOR MIXING RESULTS, IDEAL FOR SOUPS AND SAUCES

1. MAIN AGITATOR SCRAPES INSIDE OF THE KETTLE SURFACE, ADJUSTABLE SPEED CONTROL FROM 0-40 RPM'S
2. ADJUSTABLE SPEED SECONDARY AGITATOR ROTATES OPPOSITE DIRECTION IN CENTER OF MIXER.
3. STATIONARY BREAKUP BAR BREAKS UP FOODS WHILE MAIN AND SECONDARY AGITATOR MIXES THE FOOD.

PATENTED GAS COMBUSTION SYSTEM

- HIGH EFFICIENCY FORCED AIR SELF CONTAINED GAS COMBUSTION SYSTEM WITH DOUBLE PASS GENERATOR
- POWERFUL 190,000 BTU FOR FAST HEAT UP AND RECOVERY
- 50 PSI STEAM JACKER RATING FOR HIGHER COOKING TEMPERATURES
- 60, 80 AND 100 GALLON (225, 300, 375 LITERS) SELF-CONTAINED TILTING GAS MODELS, MKGL-T SERIES



ALL AVAILABLE WITH:

- CONSOLE MOUNTED CONTROL OPTIONS
- AUTOMATIC WATER METER OPTION
- STANDARD TWO-PIECE SPLIT SPRING ASSIST COVER WITH BUILT-IN SAFETY SCREEN, MEETS U.S. MACHINE SAFETY STANDARDS

COMPLETELY SELF — CONTAINED COOK CHILL SYSTEM

FEATURING A 60, 80 OR 100 GAL. SELF CONTAIN GAS HORIZONTAL MIXER KETTLE AND SELF CONTAINER PRODUCT CHILLER

Cleveland Cook Chill Systems can now be designed for smaller to mid-size operators looking to start a USDA and FDA cook chill food processing operation. Cleveland HA-G Self Contained Cook Chill Systems cooks food to a "just done state" packaged in heavy duty casings at pasteurization temperature, then rapidly chilling to 40°F in less than one hour, enabling the "Fresh" product to be stored in a refrigerated food bank at 28°F to 32°F up to 4 weeks. No external steam boiler or ice builder is required for the HA-G Cook Chill System.

1. MIXING / COOKING



HA SERIES MIXER KETTLES (HAMKGLTCC, HAMKELTCC)

Cleveland's self-contained high efficiency gas fired, and self-contained electric horizontal mixer kettles eliminates the need for an expensive large industrial boiler. Available in 60, 80 & 100 gallon models, tilting or stationary. Cleveland's patented HA series horizontal agitator lifts and folds heavy, delicate, chunky, or thin products.

2. PACKAGING



FOOD PUMP (MFS)

Cleveland' MFS model food pump provides a gentle but efficient transfer of hot and cold food from the mixer kettle into heavy duty casing pouches at the desired set amount, then safety seals the casing for chilling. The MFS-U100 model food pump can also fill retail cups and jars.

3. CHILLING



PRODUCT CHILLER/BLAST CHILLER (HBC075, HBC100 & HBC200)/(KBC750BC-2T & 3T)

Cleveland HBC series Product Chiller has built in direct-expansion refrigeration that rapidly reduces the temperature of the filled casings. No ice builder is required. Turbulent circulated flow provides full agitation to provide the most optimum rapid cooling. Available in 75, 100 & 200 gallon tank sizes. Now offering Kolpak by Cleveland walk-in blast chillers for this function as well.



SUPPORT REQUIREMENTS

The Cleveland Self Contained Cook Chill system requires no Ice Builder refrigeration or remote boilers, only a condensing unit for the product chiller. Compressed air is required for pumping from the kettle to the food pump.

THIS PAGE INTENTIONALLY LEFT BLANK

THIS PAGE INTENTIONALLY LEFT BLANK

THIS PAGE INTENTIONALLY LEFT BLANK



Welbilt's portfolio of award-winning brands includes **Cleveland™**, **Coffee Queen®**, **Convotherm®**, **Crem®**, **Crystal Tips®**, **Dean®**, **Delfield®**, **Expobar®**, **Fabrasteel®**, **Frymaster®**, **Garland®**, **Inducs®**, **Koldtech®**, **Kolpak®**, **Lincoln®**, **McCann's™**, **Merco®**, **Merrychef®**, **Multiplex®**, **RDI®**, **SerVend™**, **Spengler®**, **SunFire®** and **U.S. Range™**. Supported by service brands: **KitchenCare®**, aftermarket service; **FitKitchen®**, kitchen systems; and **KitchenConnect®**, cloud-based open platform.

Bringing innovation to the table • **welbilt.com**